



# General CE Tools Reference Summary

S131-0075-3

IBM Corporation, FE Maintenance Tools Dept. 825,  
P.O. Box 12195, Research Triangle Park, North Carolina  
27709

## **PREFACE**

This Reference Summary is primarily intended for use by IBM customer engineers. It contains illustrations and part numbers for tools that make up the standard CE tool cases as well as most of the commonly used account tools, region tools, and branch office tools. Also included are logic and equipment carts, lubricants, adhesives, touch-up paints, and other common field maintenance supplies.

Tools that are for a specific product or group of products may not be shown in this publication. For information on product tools, refer to documentation provided with the product.

In some cases, the illustration does not exactly represent the item. Illustrations are not always updated to show the latest modifications to the article represented.

**Note: The use of any item of service equipment except common handtools, that is not listed in this catalog, requires prior approval of the Program Administrator — Safety, or Industrial Hygienist, Service Division Headquarters.**

## **LEGEND**

- \* INDICATES IBM WORLD TRADE USE ONLY.
- INDICATES STANDARD METRIC SIZED TOOL.
- AR INDICATES ORDER SEPARATELY AS REQUIRED.
- ◇ WARNINGS AND SAFETY NOTICES.

## **PREFACE (CONT.)**

*Fourth Edition (August 1984)*

Information in this manual is subject to changes; any such changes will be reported in later revisions.

Publications are not stocked at the address given below; requests for IBM publications should be made to your IBM representative or to the IBM branch office serving your locality.

This manual has been prepared by the IBM System Communication Division, Planning, Production, and Controls, Department E03, P.O. Box 12195, Research Triangle Park, North Carolina 27709.

A form is provided at the back of this manual for reader's comments. If the form has been removed, comments may be sent to the address given on the front cover. IBM may use or distribute any of the information you supply in any way it believes appropriate with out incurring any obligation whatever. You may, of course, continue to use the information you supply.

The drawings and specifications contained herein shall not be reproduced in whole or in part without written permission.

© Copyright International Business Machines Corporation 1981, 1983, 1984.

## TABLE OF CONTENTS

Tool Case Assemblies	GROUP 1
Wrenches, Key and Socket	GROUP 2
Hammers, Screwdrivers	GROUP 3
Pliers, Tweezers	GROUP 4
Files, Stones, Hacksaws, Abrasives	GROUP 5
Pullers, Extractors, Grippers, Vises, Punches, Hooks	GROUP 6
Gauges, Aligners, Adjusting Tools, Timing Tools	GROUP 7
Measuring Tools, (Mechanical)	GROUP 8
Miscellaneous Tools	GROUP 9
Cleaning Tools, Brushes	GROUP 10
Oilers, Grease Guns	GROUP 11
Soldering Tools	GROUP 12
Drills, Reamers, Taps	GROUP 13
SLT/MST and other Technology Tools	GROUP 14
Oscilloscope and Accessories, Test Leads, Tips, Carts	GROUP 15
Meters, Logic Probes, Meter Leads	GROUP 16
Testers and Test Equipment, CE Cables, Plugs, Tapes	GROUP 17
Containers, Cases, Boxes, Cans, Card Caddies	GROUP 18
Field Supplies (Lubricants, Adhesives, Etc.)	GROUP 19
Alphabetical Index	GROUP 20
Numerical Index	GROUP 21

**GROUP 1**

**TOOL CASE ASSEMBLIES**

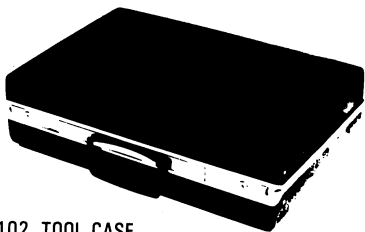

**4261102 TOOL CASE**

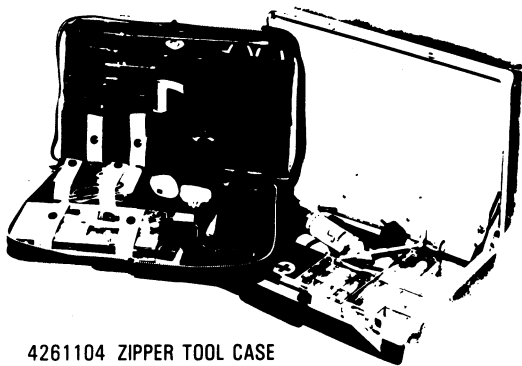

**4261104 ZIPPER TOOL CASE**

## TOOL CASE ASSEMBLIES

## EMEA CE TOOL SET

		UNITS PER ASM.
<b>4057140</b>	<b>EMEA CE TOOL CASE, BASIC</b>	<b>AR</b>
4261102	TOOL CASE	1
4261104	ZIPPER TOOL CASE	1
4013	FILE, HALF ROUND 6" MEDIUM	1
18975	HANDLE FOR FILE	1
171320	FINGER, MECHANICAL FLEXIBLE	1
450126	MIRROR, DENTAL TYPE	1
450158	RULE, POCKET, 6" SCALE	1
450466	KEY HEX & FLUTE SET	
	FOR DETAIL BREAKDOWN SEE GROUP 2-33	1
450540	HOOK SPRING, SMALL CROCHET	1
450567	BLADE, BURNISHING SILVER	1
450694	STRIPPERS WIRE, ADJUSTABLE	1
450713	OILER HAND	1
450732	BRUSH, CLEANING	1
450745	GAUGE SET, THICKNESS .001" - .030"	1
451135	RATCHET COMPLETE KIT	
	FOR DETAIL BREAKDOWN SEE GROUP 3-41	1
453693	FIRST AID KIT	1
453718	BERG CONNECTOR PROBE TIP	1
453826	SLT PROBE TIP, 6-32	2
453857	SLT PIN STRAIGHTENER	1
454352	BOX, PLASTIC 5 X 3 X 1	1
454353	WRENCH ADJUSTABLE, 1.0" OPENING 8" LONG	1
460811	SCREWDRIVER FIBER, 175 MM LONG 4 MM BLADE	1
461228	SCREWDRIVER JEWELER ASM	1
489242	TWEEZERS, BENT TIP	1
489905	PLIERS, POLYGRIP	1
1650830	WRENCH SOCKET SET	
	FOR DETAIL BREAKDOWN SEE GROUP 2-23	1
4057142	SCREWDRIVER, SLOTTED SCREW, 1/8" X 4" BLADE	1
4057143	SCREWDRIVER, SLOTTED SCREW, 1/4" X 10" BLADE	1

**GROUP 1**

**EMEA CE TOOL SET (CONTINUED)**

		<b>UNITS PER ASM.</b>
4057150	SCREWDRIVER, SLOTTED SCREW, 1/4" X 1-1/2" BLADE	1
1650864	PLIERS, DUCK BILLED 8"	1
1650866	PLIERS, LONG NOSE 6"	1
1650887	HANDLE RATCHET, 1/4" DRIVE, 4" LONG	1
1864853	SCREWDRIVER POT ADJUSTING, 1/8" X .020 BLADE	1
4056717	SCREWDRIVER, CROSS-REC, SIZE 0, 4" INSULATED BLADE	1
4056724	SCREWDRIVER, CROSS-REC, SIZE 1, 6" INSULATED BLADE	1
4056726	SCREWDRIVER, CROSS-REC, SIZE 2, 6" INSULATED BLADE	1
4261076	FLASHLIGHT	1
4261088	BOX, PLASTIC, 9 X 4 X 1	1
9900059	HOOK SPRING	1
9900060	SCREWSTARTER 8", .125" BLADE	1
9900233	SCISSOR CLAMP STRAIGHT TIP (FORCEPS)	1
9900328	SCREWSTARTER 8", .125" BLADE	1
9900688	PLIERS, CUTTING-DIAGONAL, 4", SEMI-FLUSH CUT	1

**The following P/N's are considered OPTIONAL**

453222	INTEGRATED LOGIC PROBE	OPT
489881	SOLDERING IRON, 16W, 220V	OPT
489882	SOLDERING IRON, 16W, 115V	OPT
489883	SOLDERING TIP REPLACEABLE	OPT
6428169	ESD WRIST STRAP, LARGE	OPT
6428104	METER LEAD SET (COLINE) FOR DETAIL BREAKDOWN SEE GROUP 16-120	OPT
6428167	ESD WRIST STRAP, SMALL	OPT
6428235	ILP POWER COVERTERS (CSD PRODUCTS)	OPT
6428316	ESD KIT FOR DETAIL BREAKDOWN SEE GROUP 14-99	OPT
8496278	MULTIMETER, 4-1/2 DIGITS (FLUKE 8060A)	OPT
9900167	MULTIMETER ANALOG	OPT
9900628	MULTIMETER, 3-1/2 DIGITS (FLUKE 8020)	OPT

The following P/N's are ADDITIONAL for OP Products

165866	ABRASIVE FLEXTONE
453521	"C" CLIP TOOL
453536	BRUSH, TYPE CLEANING
489036	HAMMER
9900066	WRENCH, 4 FLUTE, N.5
9900093	ALIGNING WRENCH
9900101	WRENCH, 4 FLUTE, N.6
9900173	WRENCH, 4 FLUTE, N.2
9900204	WRENCH, 4 FLUTE, N.4
9900373	KEYBUTTON PULLER
9900379	GUAGE, CARBON RIBBON
9900387	ACCESSORY BAG
9900459	SELECTRIC I/O TOOL SET FOR DETAIL BREAKDOWN SEE GROUP 1-18
9900575	HOOVEROMETER
9900619	TILT DETENT WRENCH



**GROUP 1**

**TOOL CASE ASSEMBLIES**

**FE TOOL SETS**

8550227 SMALL-BLUE CASE  
8550228 SMALL-BROWN CASE

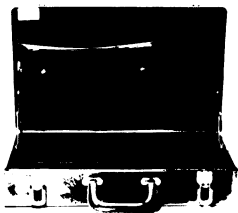

453663 PROGRAM SUPPORT

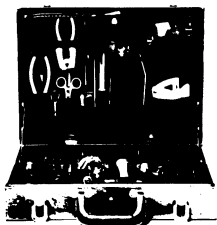

8550229 LARGE



451550 ZIPPER CASE

## TOOL CASE ASSEMBLIES

## FE TOOL SETS

		UNITS PER ASM.
<b>8550229</b>	<b>FE TOOL SET, LARGE-OLIVE CASE</b>	AR
	<b>CONSISTING OF</b>	
451548	TOOL CASE, LARGE OLIVE	1
454353	ADJUSTABLE WRENCH 8 IN.	1
460028	ALIGNING TOOLS, CODE PLATE	2
450466	ALLEN AND BRISTOL WRENCH KIT	1
	FOR DETAIL BREAKDOWN SEE GROUP 2-33	
450567	BLADE, BURNISHING	2
451148	BOX, PLASTIC, SOCKET SET	1
450732	BRUSH, CLEANING	1
8496278	CE METER	OPT
	<b>MUST BE ORDERED SEPERATE</b>	
451134	CASE, PLASTIC	1
450540	CROCHET HOOK	1
450126	DENTAL MIRROR	1
1650887	DRIVE RATCHET 1/4 IN.	1
450745	FEELER GAUGE SET, INCH	1
4011	FILE, MILL 6 IN.	1
4013	FILE, MILL, HALF ROUND 6 IN.	1
18974	FILE, PILLAR 6 IN.	1
4014	FILE, ROUND 6 IN.	1
453693	FIRST AID KIT	1
450459	GRAM GAUGE	1
1749267	GREASE GUN, SMALL	1
1650875	HAMMER 8 OZ, BALL PEEN	1
454332	HANDLE AND CORD, SOLDERING	1
18975	HANDLE, FILE	1
1650887	HANDLE, RATCHET, 1/4 IN. SQ DR	1
1749235	METRIC BILL OF MATERIAL	1
1864853	MINI POT ADJUSTING TOOL	1
451135	OFFSET RATCHET SCREWDRIVER KIT	1
18463	OIL STONE	1
450713	OILER, VALVE SPOUT	1
450465	PARTS BOX, PLASTIC-LARGE	2
454352	PARTS BOX, PLASTIC-SMALL	1
9900585	PENLIGHT	1
9900688	PLIERS, DIAGONAL, 4 IN. CUTTING	1

## GROUP 1

## TOOL CASE ASSEMBLIES

## FE TOOL SETS (CONTINUED)

		UNITS PER ASM.
1650864	PLIERS, DUCKBILL, 8 IN.	1
1650866	PLIERS, LONGNOSE, 6 IN.	1
453718	PROBE, MINI	1
1749249	PROBE, HIGH VOLTAGE—RED	1
1749250	PROBE, HIGH VOLTAGE—BLACK	1
4031	PUNCH, CENTER	1
450448	PUNCH, PIN .050 X 3 IN.	1
450407	PUNCH, PIN .062 X 4 IN.	1
450391	PUNCH, PIN .094 X 4 IN.	1
4032	PUNCH, PIN .125 X 10 IN.	1
4047	ROD, BRASS 5/16 IN. HEX X 6 IN.	1
450158	SCALE 6 IN.	1
9900233	SCISSOR, CLAMP	1
1857020	SCREWDRIVER 3/32 X 3.0 IN.	1
1650851	SCREWDRIVER 1/8 X 4.0 IN.	1
1650853	SCREWDRIVER 3/16 X 6.0 IN.	1
1650857	SCREWDRIVER 1/4 X 1.5 IN.	1
1650854	SCREWDRIVER 1/4 X 6.0 IN.	1
1650855	SCREWDRIVER 1/4 X 10.0 IN.	1
1650856	SCREWDRIVER 5/16 X 6.0 IN.	1
460811	SCREWDRIVER, FIBER	1
9900328	SCREWSTARTER, LARGE	1
9900060	SCREWSTARTER, SMALL	1
453101	SLT PIN STRAIGHTENER	1
453826	SLT PROBE TIP	2
9900026	SOLDER	1
1650786	SOLDERING ELEMENT	1
1650787	SOLDERING TIP, 1/8 IN.	1
9900059	SPRING HOOK, LARGE	1
450694	WIRE STRIPPERS	1
1650830	WRENCH AND SOCKET SET FOR DETAIL BREAKDOWN SEE GROUP 2-23	1
<b>8550227</b>	<b>FE TOOL SET, SMALL—BLUE CASE</b>	<b>AR</b>
<b>8550228</b>	<b>FE TOOL SET, SMALL—BROWN CASE CONSISTING OF</b>	<b>AR</b>
453691	TOOL CASE, SMALL—BLUE	1
453692	TOOL CASE, SMALL—BROWN	1
1650894	ADJUSTABLE WRENCH, 6 IN.	1
460028	ALIGNING TOOLS, CODE PLATE	2

## TOOL CASE ASSEMBLIES

## FE TOOL SETS (CONTINUED)

		UNITS PER ASM.
450466	ALLEN AND BRISTOL WRENCH KIT FOR DETAIL BREAKDOWN SEE GROUP 2-33	1
450567	BLADE, BURNISHING	2
451148	BOX, PLASTIC, SOCKET SET	1
450732	BRUSH, CLEANING	1
8496278	CE METER	OPT
	MUST BE ORDERED SEPERATE	
451134	CASE, PLASTIC	1
450540	CROCHET HOOK	1
450126	DENTAL MIRROR	1
1650887	DRIVE RATCHET 1/4 IN.	1
1650786	ELEMENT, SOLDERING	1
450745	FEELER GAUGE SET, INCH	1
453693	FIRST AID KIT	1
450459	GRAM GAUGE	1
1749267	GREASE GUN, SMALL	1
1650874	HAMMER 4 OZ	1
454332	HANDLE AND CORD, SOLDERING	1
1650887	HANDLE, RATCHET, 1/4 IN. SQ DR	1
1749235	METRIC BILL OF MATERIAL	1
1864853	MINI-POT ADJUSTING TOOL	1
451135	OFFSET RATCHET SCREWDRIVER KIT	1
450713	OILER, VALVESPOUT	1
18463	OILSTONE	1
450465	PARTS BOX, LARGE	1
454352	PARTS BOX, SMALL	1
9900585	PENLIGHT	1
9900688	PLIERS, DIAGONAL 4 IN. CUTTING	1
1650864	PLIERS, DUCKBILLED 8 IN.	1
1650866	PLIERS, LONGNOSE 6 IN.	1
453718	PROBE, MINI	1
1749249	PROBE, HIGH VOLTAGE-RED	1
1749250	PROBE, HIGH VOLTAGE-BLACK	1
4031	PUNCH, CENTER	1
450448	PUNCH, PIN .050 X 3 IN.	1
450407	PUNCH, PIN .062 X 4 IN.	1

## GROUP 1

## TOOL CASE ASSEMBLIES

## FE TOOL SETS (CONTINUED)

		UNITS PER ASM.
450391	PUNCH, PIN .094 X 4 IN.	1
4047	ROD, BRASS	1
450158	SCALE 6 IN.	1
1857020	SCREWDRIVER 3/32 X 3.0 IN.	1
1650851	SCREWDRIVER 1/8 X 4.0 IN.	1
1650853	SCREWDRIVER 3/16 X 6.0 IN.	1
1650857	SCREWDRIVER 1/4 X 1.5 IN.	1
1650854	SCREWDRIVER 1/4 X 6.0 IN.	1
1650856	SCREWDRIVER 5/16 X 6.0 IN.	1
9900328	SCREWSTARTER, LARGE	1
9900060	SCREWSTARTER, SMALL	1
9900233	SCISSOR CLAMP	1
453101	SLT PIN STRAIGHTENER	1
453826	SLT PROBE TIP	2
9900059	SPRING HOOK	1
9900026	SOLDER	1
1650787	SOLDERING TIP, 1/8 IN.	1
450694	WIRE STRIPPERS	1
1650830	WRENCH AND SOCKET SET	1
	FOR DETAIL BREAKDOWN SEE GROUP 2-23	
<b>451550</b>	<b>ZIPPER CASE</b>	<b>AR</b>
<b>453663</b>	<b>PROGRAM SUPPORT CASE</b>	<b>AR</b>

SNAP-ON<sup>®</sup> TOOLS ARE WARRANTED FOR LIFE TIME USE

**The following P/N's are considered OPTIONAL**

6428316	ESD KIT FOR DETAIL BREAKDOWN SEE GROUP 14-99	OPT
6428169	ESD WRIST STRAP, LARGE	OPT
6428167	ESD WRIST STRAP, SMALL	OPT
6428235	ILP POWER COVERTERS (CSD PRODUCTS)	OPT
453222	INTEGRATED LOGIC PROBE	OPT
6428104	METER LEAD SET (COLINE) FOR DETAIL BREAKDOWN SEE GROUP 16-120	OPT
9900167	MULTIMETER ANALOG	OPT
9900628	MULTIMETER, 3-1/2 DIGITS (FLUKE 8020)	OPT
8496278	MULTIMETER, 4-1/2 DIGITS (FLUKE 8060A)	OPT
489882	SOLDERING IRON, 16W, 115V	OPT
489881	SOLDERING IRON, 16W, 220V	OPT
489883	SOLDERING TIP, REPLACEABLE	OPT

**GROUP 1**

**TOOL CASE ASSEMBLIES**

**CSD TOOL SETS**

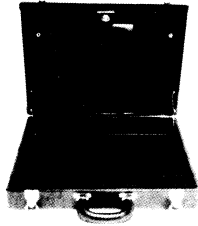

**9900728 SLIM LINE**

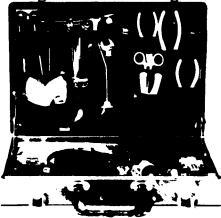

**1643916 SMALL BLUE  
1643917 SMALL BROWN**

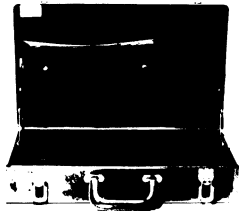

**453663 PROGRAM SUPPORT**

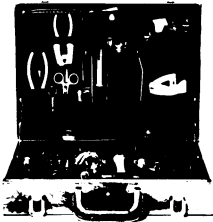

**1643918 LARGE**



**451550 ZIPPER CASE**

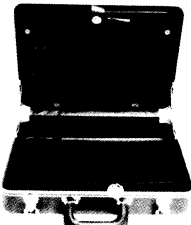

**9900579 MOLDED**

## CSD TOOL SETS

		UNITS PER ASM.
<b>1643918</b>	<b>CSD TOOL SET, LARGE-OLIVE CASE CONSISTING OF</b>	<b>AR</b>
451548	TOOL CASE LARGE, OLIVE	1
454353	ADJUSTABLE WRENCH 8 IN.	1
460028	ALIGNING TOOLS, CODE PLATE	2
450466	ALLEN AND BRISTOL WRENCH KIT FOR DETAIL BREAKDOWN SEE GROUP 2-33	1
450660	BENDING TOOL, WCR TERMINAL	1
450567	BLADE, BURNISHING	2
451148	BOX, SOCKET WRENCH SET	1
450732	BRUSH, CLEANING	1
451134	CASE, PLASTIC	1
3339	CLEANER, CHUTE BLADE	1
450540	CROCHET HOOK	1
450126	DENTAL MIRROR	1
450054	DOWEL PULLER	1
1650887	DRIVE RATCHET, 1/4 IN.	1
1650786	ELEMENT, SOLDERING	1
450745	FEELER SET, INCH	1
453693	FIRST AID KIT	1
18975	FILE HANDLE	1
4011	FILE, MILL 6 IN.	1
4013	FILE MILL, HALF ROUND 6 IN.	1
18974	FILE, PILLAR 6 IN.	1
4014	FILE, ROUND 6 IN.	1
450459	GRAM GAUGE	1
1749267	GREASE GUN, SMALL	1
1650875	HAMMER 8 OZ, BALL PEEN	1
454332	HANDLE AND CORD, SOLDERING	1
18975	HANDLE, FILE	1
1650887	HANDLE, RATCHET, 1/4 IN. SQ DR	1
9900373	KEYTOP PULLER	1
1749235	METRIC BILL OF MATERIAL	1
1864853	MINI-POT ADJUSTING TOOL	1
451135	OFFSET RATCHET SCREWDRIVER KIT	1



## GROUP 1

## TOOL CASE ASSEMBLIES

## CSD TOOL SETS (CONTINUED)

UNITS  
PER ASM.

18463	OIL STONE	1
450713	OILER, VALVESPOUT	1
9900585	PENLIGHT	1
9900688	PLIERS, DIAGONAL 4 IN. CUTTING	1
1650864	PLIERS, DUCKBILL 8 IN.	1
1650866	PLIERS, LONGNOSE 6 IN.	1
453198	PLIERS, VISE GRIP	1
453718	PROBE, MINI	1
1749249	PROBE, HIGH VOLTAGE—RED	1
1749250	PROBE, HIGH VOLTAGE—BLACK	1
4031	PUNCH, CENTER	1
450448	PUNCH, PIN .050 X 3 IN.	1
450407	PUNCH, PIN .062 X 4 IN.	1
450391	PUNCH, PIN .094 X 4 IN.	1
452397	REED RELAY PULLER	1
4047	ROD, BRASS 5/16 IN. HEX X 6 IN.	1
1012444	ROD, FOLLOWER, KEYTOP REMOVAL	1
450158	SCALE 6 IN.	1
9900233	SCISSOR, CLAMP	1
1857020	SCREWDRIVER 3/32 X 3.0 IN.	1
1650851	SCREWDRIVER 1/8 X 4.0 IN.	1
1650853	SCREWDRIVER 3/16 X 6.0 IN.	1
1650857	SCREWDRIVER 1/4 X 1.5 IN.	1
1650854	SCREWDRIVER 1/4 X 6.0 IN.	1
1650855	SCREWDRIVER 1/4 X 10.0 IN.	1
1650856	SCREWDRIVER 5/16 X 6.0 IN.	1
460811	SCREWDRIVER, FIBER	1
9900328	SCREWSTARTER, LARGE	1
*450619	SCREWSTARTER, SMALL	1
453101	SLT PIN STRAIGHTENER	1
453826	SLT PROBE TIPS	2
9900026	SOLDER	1
9900059	SPRING HOOK, LARGE	1
453160	TIMING TOOL, STARWHEEL	1
1650787	TIP, 1/8 IN SOLDERING	1
450694	WIRE STRIPPERS	1
1650830	WRENCH AND SOCKET SET	1
	FOR DETAIL BREAKDOWN SEE	
	GROUP 2-23	

## TOOL CASE ASSEMBLIES

## CSD TOOL SETS (CONTINUED)

		UNITS PER ASM.
1643917	CSD TOOL SET, SMALL-BROWN OR	AR
1643916	CSD TOOL SET, SMALL-BLUE CONSISTING OF	AR
453692	CASE, SMALL-BLUE	1
453691	CASE, SMALL-BROWN	1
1650894	ADJUSTABLE WRENCH 6 IN.	1
450466	ALLEN AND BRISTOL WRENCH KIT FOR DETAIL BREAKDOWN SEE GROUP 2-33	1
460028	ALIGNING TOOLS, CODE PLATE	2
450660	BENDING TOOL, WCR TERMINAL	1
450567	BLADE, BURNISHING	2
450465	BOX, PLASTIC PARTS	1
451148	BOX, PLASTIC SOCKET SET	1
450732	BRUSH, CLEANING	1
451134	CASE, PLASTIC	1
4031	CENTER PUNCH	1
3339	CLEANER, CHUTE BLADE-CARD SAW	1
450540	CROCHET HOOK	1
450126	DENTAL MIRROR	1
450054	DOWEL PULLER	1
1650887	DRIVE RATCHET 1/4 IN.	1
1650786	ELEMENT, SOLDERING	1
450745	FEELER SET, INCH	1
453693	FIRST AID KIT	1
1012444	FOLLOWER ROD, KEYTOP REMOVAL	1
450459	GRAM GAUGE	1
1749267	GREASE GUN, SMALL	1
1650874	HAMMER, 4 OZ	1
454332	HANDLE AND CORD, SOLDERING	1
1650887	HANDLE, RATCHET, 1/4 IN. SQ DR	1
9900373	KEYTOP PULLER	1
1749235	METRIC BILL OF MATERIAL	1
1864853	MINI-POT ADJUSTING TOOL	1
451135	OFFSET RATCHET SCREWDRIVER KIT	1
18463	OIL STONE	1
450713	OILER, VALVE SPOUT	1
9900585	PENLIGHT	1

## TOOL CASE ASSEMBLIES

CSD TOOL SETS (CONTINUED)		UNITS PER ASM.
9900688	PLIERS, DIAGONAL 4 IN. CUTTING	1
1650864	PLIERS, DUCKBILL 8 IN.	1
1650866	PLIERS, LONGNOSE 6 IN.	1
453718	PROBE, MINI	1
1749249	PROBE, HIGH VOLTAGE—RED	1
1749250	PROBE, HIGH VOLTAGE—BLACK	1
450448	PUNCH, PIN .050 X 3 IN.	1
450407	PUNCH, PIN .062 X 4 IN.	1
450391	PUNCH, PIN .094 X 4 IN.	1
452397	REED RELAY PULLER	1
4047	ROD, BRASS 5/16 IN. HEX X 6 IN.	1
450158	SCALE 6 IN.	1
9900233	SCISSOR, CLAMP	1
1857020	SCREWDRIVER 3/32 X 3.0 IN.	1
1650851	SCREWDRIVER 1/8 X 4.0 IN.	1
1650853	SCREWDRIVER 3/16 X 6.0 IN.	1
1650857	SCREWDRIVER 1/4 X 1.5 IN.	1
1650854	SCREWDRIVER 1/4 X 6.0 IN.	1
1650856	SCREWDRIVER 5/16 X 6.0 IN.	1
460811	SCREWDRIVER, FIBER	1
9900328	SCREWSTARTER, LARGE	1
*450619	SCREWSTARTER, SMALL	1
453101	SLT PIN STRAIGHTENER	1
453826	SLT PROBE TIPS	2
21213	SOCKET WRENCH, STARWHEEL	1
9900026	SOLDER	1
9900059	SPRING HOOK	1
453160	TIMING TOOL STARWHEEL	1
1650787	TIP, SOLDERING 1/8 IN.	1
450694	WIRE STRIPPERS	1
1650830	WRENCH AND SOCKET SET FOR DETAIL BREAKDOWN SEE GROUP 2-23	1
173993	WRENCH, BOX TUBE FITTING 5/16 X 3/8	1
451550	ZIPPER CASE	AR
9900728	TOOL CASE SLIM LINE	AR
9900579	TOOL CASE MOLDED	AR
453663	PROGRAM SUPPORT CASE	AR

**TOOL CASE ASSEMBLIES****GROUP 1**

		<b>UNITS PER ASM.</b>
<b>The following P/N's are considered OPTIONAL</b>		
6428316	ESD KIT FOR DETAIL BREAKDOWN SEE GROUP 14-99	OPT
6428169	ESD WRIST STRAP, LARGE	OPT
6428167	ESD WRIST STRAP, SMALL	OPT
6428235	ILP POWER CONVERTERS (CSD PRODUCTS)	OPT
453222	INTEGRATED LOGIC PROBE	OPT
6428104	METER LEAD SET (COLINE) FOR DETAIL BREAKDOWN SEE GROUP 16-120	OPT
9900167	MULTIMETER ANALOG	OPT
9900628	MULTIMETER, 3-1/2 DIGITS (FLUKE 8020)	OPT
8496278	MULTIMETER, 4-1/2 DIGITS (FLUKE 8060A)	OPT

## TOOL CASE ASSEMBLIES

## SELECTRIC I/O TOOL SET

UNITS  
PER ASM.

9900459	SELECTRIC I/O TOOL SET (FOR SELECTRIC TRAINED C.E.'S) CONSISTING OF	AR
9900375	FIXTURE, DYNAMIC HALF CYCLE	1
453523	GAUGE, WIRE FEELER	1
9900210	HOOK, SPRING-HOLDING	1
9900112	HOOVEROMETER	1
1650852	SCREWDRIVER 8 IN.	1
9900242	SPINTITE 1/4 X 5/16 IN.	1
9900105	SPRING HOOK, SMALL	1
9900190	T-BENDER (FROM PUSHERS)	1
453604	TOOL, HALF CYCLE-REDUCED FUNCTION	†
9900427	WHEEL, OPERATIONAL INDEX	1
9900208	WRENCH 3/16 X 7/32 IN.	1
9900266	WRENCH 1/4 X 5/32 IN.	1
9900005	WRENCH 1/4 X 5/16 IN. (SPECIAL)	1
9900090	WRENCH 3/4 X 5/8 IN. (PIN FEED PLATEN)	1
9900173	WRENCH, NO. 2-4 FLUTE (C1-C2)	1
9900216	WRENCH, NO. 2-6 FLUTE (GEARLESS TILT)	1
9900028	WRENCH, NO. 4-6 FLUTE (ROTATE PULLEY)	1
9900200	WRENCH, NO. 6-6 FLUTE (OPERATIONAL RATCHETS)	1
9900255	WRENCH, NO. 133-6 FLUTE (IDLER GEAR)	1
9900226	WRENCH VELOCITY CONTROL PLATE	1

**TOOL CASE ASSEMBLIES**

**GROUP 1**

<b>CSD INITIAL ISSUE BASE LINE TOOLS</b>		<b>UNITS PER ASM.</b>
<b>9900008</b>	<b>INITIAL ISSUE BASE LINE TOOLS CONSISTING OF</b>	<b>AR</b>
	<b>SCREWDRIVERS AND SCREWSTARTERS</b>	
1650854	LARGE, 6 IN.	1
1650851	SMALL, 5 IN.	1
9900070	SMALL, 3 IN. WITH PALLET CLIP	1
9900362	JEWELERS, LARGE	1
9900361	JEWELERS, SMALL	1
9900060	SCREWSTARTER, MEDIUM	1
	<b>PLIERS</b>	
9900064	GAS	1
9900688	DIAGONALS, 4 IN.	1
9900317	GRIP RING, SMALL	1
1650866	LONG NOSE, 8 IN.	1
9900233	SCISSOR, CLAMP	1
1650864	DUCKBILL, 8 IN.	1
9900365	TWEEZERS	1
	<b>SPRINGHOOKS</b>	
9900059	LARGE	1
9900105	SMALL	1
9900210	SPRING HOOK, CAPTIVE	1
	<b>SETSCREW WRENCHES</b>	
<b>9900419</b>	<b>SETSCREW WRENCH B/M CONSISTING OF</b>	<b>1</b>
9900101	4 FLUTE, NO. 6	1
9900066	4 FLUTE, NO. 5	1
9900204	4 FLUTE, NO. 4	1
9900173	4 FLUTE, NO. 2	1

## TOOL CASE ASSEMBLIES

9900008	CSD ISSUE BASE LINE TOOLS (CONTINUED)	UNITS PER ASM.
---------	--	-------------------

**SETSCREW WRENCHES  
(CONTINUED)**

9900029	6 FLUTE, 1/4 IN.	1
9900255	6 FLUTE, NO. 133	1
9900103	6 FLUTE, NO. 10	1
9900102	6 FLUTE, NO. 8	1
9900200	6 FLUTE, NO. 6	1
9900028	6 FLUTE, NO. 4	1
9900216	6 FLUTE, NO. 2	1
9900058	HEX, NO. 8	1
9900202	HEX, NO. 6	1
9900062	HEX, NO. 4	1
9900358	HEX, NO. 2	1
450467	KEY WRENCH POUCH	1

**WRENCHES**

9900426	BOX END, 1/4 IN. X 5/16 IN.	1
9900013	OPEN END, 11/32 IN. X 3/8 IN.	1
9900182	BOX END, 3/8 IN. X 7/16 IN.	1
9900266	OPEN END, 1/8 IN. X 5/32 IN.	1
9900005	OPEN END, 1/4 IN. X 5/16 IN.	2
9900208	OPEN END THIN, 3/16 IN. X 7/32 IN.	1
1650843	OPEN END, 3/16 IN. X 7/32 IN.	1
9900422	OPEN END, 3/8 IN. X 7/16 IN.	1
9900242	SPINNER, 1/4 IN. X 5/16 IN.	1
9900226	VELOCITY ADJUSTING WRENCH	1
9900619	TILT DETENT WRENCH	1

**TYPE ALIGNMENT AND FORMING  
TOOLS**

9900093	ALIGNING WRENCH	2
9900268	PEENERS	1
9900076	HAMMER (2 OZ.)	1
9900730	KEYLEVER FORMING TOOL	1
9900094	T BENDER	1
9900589	ALIGNMENT TOOL, COMBINED	1

## TOOL CASE ASSEMBLIES

**9900008 CSD ISSUE BASE LINE TOOLS  
(CONTINUED)**
**UNITS  
PER ASM.**
**MEASURING AND TESTING DEVICES**

450158	SCALE, 6 IN.	1
9900468	GAUGE, FEELER	1
460870	SCALE, PUSH-PULL 0-6 LB	1
9900379	GAUGE, CARBON RIBBON	1
9900575	HOOVEROMETER	1
9900519	GAUGE, PLATEN ALIGNMENT	1

**FULCRUM WIRES**

1012444	TAP STOP	1
1118213	TYPEBAR KEY LEVER	1
1016718	TYPEBAR PIVOT	1

**SOLDERING EQUIPMENT**

454332	HANDLE, SOLDERING	1
9900016	SOLDERING TIP 50 WATT	1
9900381	SOLDERING ELEMENT 27 WATT	1
9900382	TIPLETT FOR SMALL ELEMENT 9900381	1
9900026	SOLDER	1

**ABRASIVES**

4011	FILE, MILL 6 IN. MEDIUM	1
9900007	HANDLE, FILE	1
165866	FLEXSTONE	1
450567	BLADE, BURNISHING SILVER CONTACT	1
4014	FILE, ROUND 6 IN. MEDIUM	1



## GROUP 1

## TOOL CASE ASSEMBLIES

**9900008 CSD ISSUE BASE LINE TOOLS  
(CONTINUED)**

**UNITS  
PER ASM.**

**CLEANING TOOLS**

9900327	BOTTLE, CLEANING FLUID	1
9900049	COVER, CLEANING FLUID BOTTLE	1
3701	BRUSH, RED HANDLED	1
453536	BRUSH, TYPE CLEANING	1
9900050	SPONGE, CLEANING	1
9900014	BRUSH, OIL	1

**MISCELLANEOUS TOOLS**

9900387	ACCESSORY BAG	1
9900081	FIRST AID KIT, SMALL	1
9900375	DYNAMIC HALF CYCLE TOOL	1
9900427	HAND CYCLE WHEEL	1
450467	KEYWRENCH POUCH (PART OF B/M 9900419)	1
9900034	OILER-COMPLETE	1
9900373	KEYBUTTON PULLER	1
453521	"C" CLIP TOOL	1

**THE FOLLOWING IS NOT INCLUDED IN B/M 9900008**

9900728	TOOL CASE, SLIMLINE	AR
9900579	TOOL CASE MOLDED	AR
9900621	REPLACEMENT PALLET	AR
9900167	®TRIPLETT METER	AR
9900534	POWER CLEANER	AR
9900709	CAM FOLLOWER REMOVAL TOOL	AR

**GROUP 2**

**WRENCHES, KEY AND SOCKET**

**1650830 WRENCH AND SOCKET SET ASSEMBLY  
CONSISTING OF**

	<b>UNITS PER ASM</b>
1650831 SOCKET, 3/16 IN., 6 POINT	1
• 1650832 SOCKET, 7/32 IN. (5.5 MM), 6 PT	1
1650833 SOCKET, 1/4 IN., 6 PT	1
• 1650834 SOCKET, 5/16 IN. (8 MM), 12 PT	1
1650835 SOCKET, 11/32 IN., 12 PT	1
1650836 SOCKET, 3/8 IN., 12 PT	1
1650837 SOCKET, 7/16 IN., 12 PT	1
1650838 SOCKET, 1/2 IN., 12 PT	1
1650839 SOCKET, 9/16 IN., 12 PT	1
1650840 HANDLE, SOCKET, 1/4 IN. DRIVE	1
1650841 HANDLE, SOCKET, SWIVEL, 1/4 IN. DR.	1
1650842 UNIVERSAL, SOCKET DRIVE, 1/4 IN.	1
1650843 OPEN END, 7/32 IN. X 3/16 IN.	1
1650844 BOX/OPEN END, 1/4 X 1/4 IN., 6 PT	1
• 1650845 BOX/OPEN END, 5/16 X 5/16 IN. (8 MM), 6 PT	1
1650846 BOX/OPEN END, 11/32 X 11/32 IN., 6 PT	1
1650847 BOX/OPEN END, 3/8 X 3/8 IN., 6 PT	1
1650848 BOX/OPEN END, 7/16 X 7/16 IN., 12 PT	1
1650849 BOX/OPEN END, 1/2 X 1/2 IN., 12 PT	1
1650850 BOX/OPEN END, 9/16 X 9/16 IN., 12 PT	1

THE FOLLOWING IS NOT INCLUDED IN 1650830:

451148 BOX, PLASTIC SOCKET SET	AR
1650887 HANDLE, RATCHET, 1/4 IN. DRIVE	AR

**SNAP-ON® TOOLS ARE WARRANTED FOR LIFE TIME USE**

**GROUP 2****WRENCHES, KEY AND SOCKET****METRIC B/M 1749235, CONSISTING OF**

- 1 - 1749236 - 6 MM ALLEN WRENCH
- 1 - 1749237 - 5 MM ALLEN WRENCH
- 1 - 1749238 - 3 MM ALLEN WRENCH
- 1 - 1857021 - 5 MM SIX POINT SOCKET
- 1 - 1749262 - 6 MM, SIX POINT, SOCKET
- 1 - 1749239 - 7 MM, SIX POINT, SOCKET
- 1 - 1749240 - 10 MM, SIX POINT, SOCKET
- 1 - 1749241 - 13 MM, SIX POINT, SOCKET
- 1 - 1857022 - 5 MM COMBINATION WRENCH
- 1 - 9900768 - 5.5 MM COMBINATION WRENCH
- 1 - 1749261 - 6 MM COMBINATION WRENCH
- 1 - 1749242 - 7 MM COMBINATION WRENCH
- 1 - 1749243 - 10 MM COMBINATION WRENCH
- 1 - 1749244 - 13 MM COMBINATION WRENCH
- 1 - 1749245 - METRIC FEELER GAUGE SET
- 1 - 1749246 - 150 MM SCALE

**PN Designated By the Symbol • Address  
Inch and Metric Tool Requirements**

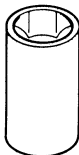
**SOCKET WRENCH 1/4 IN. DRIVE**

- 1650831 3/16 IN.
- 1650832 7/32 IN. 5.5 MM
- 1857021 5 MM
- 1749262 6 MM
- 1650833 1/4 IN.
- 1749239 7 MM
- 1650834 5/16 IN. 8 MM
- 1650835 11/32 IN.
- 1650836 3/8 IN.
- 1749240 10 MM
- 1650837 7/16 IN.
- 1650838 1/2 IN.
- 1749241 13 MM
- 1650839 9/16 IN.

# WRENCHES, KEY AND SOCKET GROUP 2

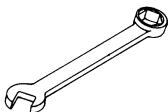

**WRENCH, BOX AND OPEN END,  
COMB-6 POINT**

1857022	5 MM
9900768	5.5 MM
1749261	6 MM
1650844	1/4 IN.
1749242	7 MM
• 1650845	5/16 IN. 8 MM
1650846	11/32 IN.
1650847	3/8 IN.

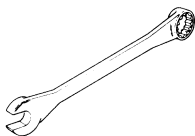

**WRENCH, BOX AND OPEN END  
COMB-12 POINT**

461617	1/4 IN.
1749243	10 MM
1650848	7/16 IN.
1650849	1/2 IN.
1749244	13 MM
1650850	9/16 IN.

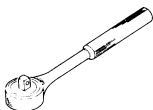

**1650887 WRENCH, RATCHET  
1/4 IN. SQUARE  
DRIVE**



**451913 HEX WRENCH  
ADAPTER 3/16**

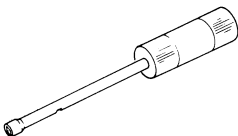

**9900242 SPINNER  
1/4 X 5/16 IN.**

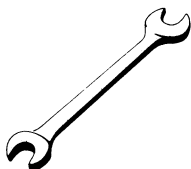

**9900226 VELOCITY ADJUSTING  
WRENCH**

**GROUP 2****WRENCHES, KEY AND SOCKET****WRENCH, OPEN END, FIXED**

9900266	1/8	X	5/32 IN.
9900208	3/16	X	7/32 X 3 IN. THIN.
1650843	3/16	X	7/32
9900005	1/4	X	5/16 X 4 IN.
2244061	9/32	X	11/16 IN.
9900013	11/32	X	3/8 IN.
9900090	5/8	X	3/4 IN. THIN

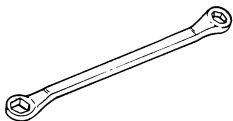

**9900182 WRENCH, BOX END**  
3/8 X 7/16 IN.

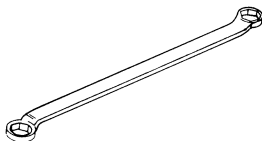

**9900426 WRENCH, BOX END**  
1/4 X 5/16 IN.

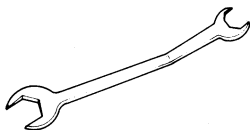

**9900422 WRENCH, MT/ST**  
7/16 X 3/8 IN.



**9900619 WRENCH, TILT  
DETENT-SELECTRIC**  
3/16 IN OPEN X 1/8  
IN. BOX

# WRENCHES, KEY AND SOCKET

GROUP 2



**WRENCH, OPEN END, FIXED  
7 IN. LONG**

460307	3/16	X	3/16 IN. THIN
460308	7/32	X	7/32 IN. THIN
460304	1/4	X	1/4 IN.
460305	5/16	X	5/16 IN.
460309	11/32	X	11/32 IN.
460306	3/8	X	3/8 IN.
605902	1/4	X	1/4 IN.



**\*489857 WRENCH, OPEN END,  
5.5 X 6 MM**

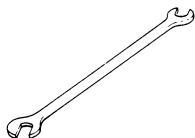

**9900266 WRENCH, OPEN END,  
1/8 X 5/32 IN. THIN**



**\*4261090 WRENCH, OPEN END,  
7/32 X 3/16 IN.**

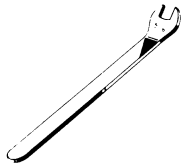

**\*489878 WRENCH, OPEN END,  
5/16 IN., OFFSET**

**GROUP 2**

**WRENCHES, KEY AND SOCKET**

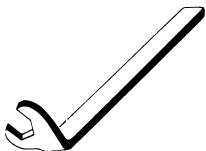

**460311 WRENCH, OPEN END,  
1/4 IN. OFFSET**



**\*489841 WRENCH, OFFSET, 9  
X 9.5 MM  
\*489840 WRENCH, OFFSET,  
10 X 11 MM**

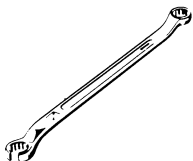

**\*489902 WRENCH, BOX  
TUBE FITTING 1/4  
X 5/16 IN.**

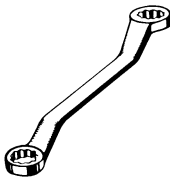

**856481 WRENCH BOX,  
11/16 X 3/4 IN.**

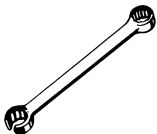

**173993 WRENCH, BOX,  
TUBE FITTING, 5/16  
X 3/8 IN.**

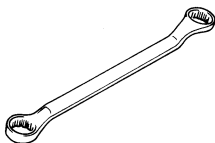

**9900182 WRENCH, BOX,  
3/8 X 7/16**

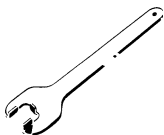

**453607 WRENCH, LEVELING  
PAD**

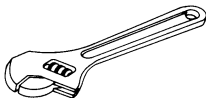

**WRENCH, ADJUSTABLE**

- 1650894 6 IN.**
- 454353 8 IN.**
- 450177 10 IN.**
- 2200031 12 IN.**

WRENCHES, KEY AND SOCKET GROUP 2

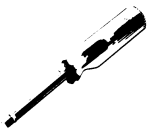

1650840 HANDLE, SOCKET WRENCH, 1/4 IN. DR.



1650841 HANDLE, SOCKET WRENCH, SWIVEL, 1/4 IN. DR.  
1650887 WRENCH, RATCHET 1/4 IN. DR

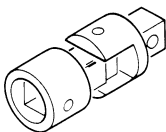

1650842 SOCKET, UNIVERSAL, 1/4 IN. DRIVE

SOCKET ADAPTER, HEX HEAD DRIVER



453397 7/64 IN., 1/4 DR  
2200161 9/64 IN., 1/4 DR  
4463820 6 MM 3/8" DR.  
2108914 5/32 IN., 3/8 DR  
7030589 1/4 IN., 3/8 DR  
2108040 5/16 IN., 3/8 DR

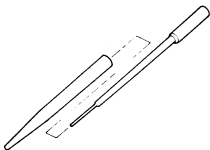

9900369 1/8 IN. SELECTRIC TILT DETENT ADJ. 5/64 IN. 224 B/S ADJUST

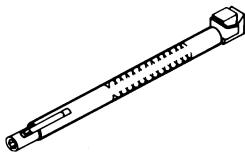

9900375 SELECTRIC DYNAMIC HALF CYCLE TOOL 3/16 IN. DRIVER



1805216 SOCKET ADAPTER 3/8" to 1/4" DR.



9900022 WRENCH, OBSTRUCTION 5/16 IN.



**GROUP 2 WRENCHES, KEY AND SOCKET**



**\*489174 SOCKET WRENCH  
WITH SCREWDRIVER,  
KEY PUNCH**



**WRENCH, OPEN END**  
450802 1/8 X 3/16 IN.,  
PRINT HEAD NUT  
\*489895 1/2 X 3/8 IN.  
\*9007472 9/16 X 5/8 IN.

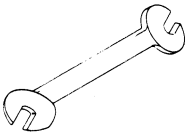

**2200464 WRENCH, 30 DEG  
-60 DEG 7/16 IN.  
OPEN END 2314**

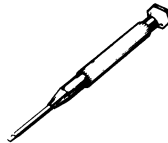

**\*8021711 ALLEN  
SCREWDRIVER, HEX  
1.27 MM**

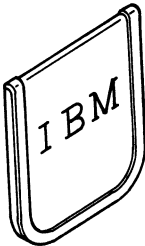
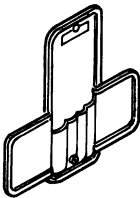

**450467 POUCH, CANVAS**

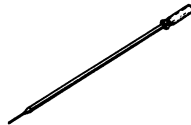

**SCREWDRIVER, EXTENSION**  
450721 NO. 10, 6 FLUTE,  
12 IN.  
450722 NO. 5, 4 FLUTE, 12  
IN.

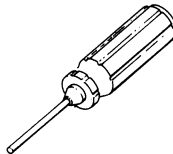

**460812 SCREWDRIVER, 6  
FLUTE, .110 DIA.**

**WRENCHES, KEY AND SOCKET GROUP 2**



**21213 WRENCH, SOCKET,  
.190 AND .221 IN.  
KEY PUNCH**



**453608 WRENCH, HEX, TAPE  
HEAD**

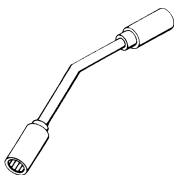

**2515390 WRENCH, CAPSTAN  
MOTOR 2420**

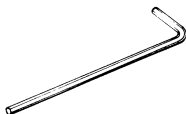

**2200204 WRENCH, HEX, 9 IN.  
2321**

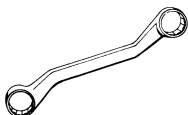

**834327 WRENCH, SELECTOR ADJ  
LOCKNUT, 9/32  
HEX X 1/4  
HEX 1419**



**605903 WRENCH, 1/4 IN.,  
OFFSET, T-HANDLE**

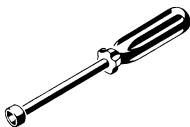

**453609 WRENCH,  
TAPE HEAD ADJ.**

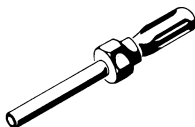

**454350 WRENCH, DRUM HEAD  
ADJUSTING**

**GROUP 2      WRENCHES, KEY AND SOCKET**

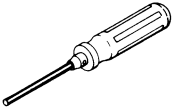

**2200176 DRIVER, SPLINE,  
3-1/2 IN.  
TIP 2301-2303**



**461129 WRENCH, SPANNER**



**450128 WRENCH, SPANNER,  
4 IN.**

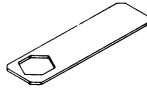

**2200104 WRENCH, FRONT DOOR,  
2314**



**461137 KEY, HEX, .12 IN.  
DIA., TOWER LATCH**



**KEY, SOCKET HD SCR, TEE  
HANDLE**

**460947 3/16 IN.  
461275 .188 IN.**

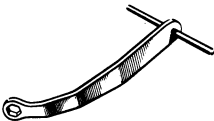

**\*489239 WRENCH, BOX, 8  
MM, T-HANDLE**

## WRENCHES, KEY AND SOCKET GROUP 2

### 450466 KEY SET HEX AND FLUTED CONSISTING OF

450467 POUCH, CANVAS

#### SOCKET KEY, HEX (ALLEN)

	DIMENSIONS, INCH			PART NUMBER	DIMENSIONS, MM		
	A	B	C		A	B	C
•	.028	.3	1.2	2108315	.71	7.6	30
•	.050	.6	2.9	74925	1.27	15.2	74
•	.062	.6	3.1	77009	1.57	15.2	79
•	.077	.7	3.3	450372	1.96	17.8	84
•	.093	.8	3.6	450373	2.36	20.3	91
•	.108	.8	2.2	2108490	2.74	20.3	56
•	.125	.9	3.9	116574	3.18	22.9	99
•	.140	1.0	2.5	451553	3.56	25.4	64
•	.155	1.0	4.4	7231	3.94	25.4	112
•	.187	1.1	2.9	178397	4.75	27.9	74

#### SOCKET KEY, 6 FLUTE (BRISTOL)

	DIMENSIONS, INCH			PART NUMBER	DIMENSIONS, MM		
	A	B	C		A	B	C
•	.047	.6	4.0	9900216	1.19	15.2	102
•	.060	.5	4.0	9900028	1.52	12.5	102
•	.070	.6	3.1	9900200	1.78	15.2	79
•	.094	.7	3.2	9900102	2.39	17.8	81
•	.110	.8	3.6	9900103	2.79	20.3	91
•	.133	.9	2.3	9900255	3.38	22.9	58
•	.168	1.0	4.1	452395	4.27	25.4	104

## GROUP 2

## WRENCHES, KEY AND SOCKET

**9900419 KEY SET, TYPEWRITER  
CONSISTING OF:**

450467 POUCH, CANVAS

SOCKET KEY, HEX (ALLEN)

DIMENSIONS, INCH			PART NUMBER	DIMENSIONS, MM		
A	B	C		A	B	C
NO. 2			9900358			
.050 X	.6 X	4.0	9900062	1.27 X	15.2 X	74
NO. 6			9900202			
NO. 8			9900058			
.093 X	.8 X	3.6	450373	2.36 X	20.3 X	91
.108 X	.8 X	2.2	2108490	2.74 X	20.3 X	56
.125 X	.9 X	3.9	116574	3.18 X	22.9 X	99
.140 X	1.0 X	2.5	451553	3.56 X	25.4 X	64
.156			9900339	3.96		
.187 X	1.1 X	2.9	178397	4.75 X	27.9 X	74

SOCKET KEY, 6 FLUTE (BRISTOL)

DIMENSIONS, INCH			PART NUMBER	DIMENSIONS, MM		
A	B	C		A	B	C
.047 X	.6 X	4.0	9900216	1.19 X	15.2 X	102
.060 X	.5 X	4.0	9900028	1.52 X	12.5 X	102
.070 X	.6 X	3.1	9900200	1.78 X	15.2 X	79
.094 X	.7 X	3.2	9900102	2.39 X	17.8 X	81
.110 X	.8 X	3.6	9900103	2.79 X	20.3 X	91
.133 X	.9 X	2.3	9900255	3.38 X	22.9 X	58
.250			9900029	6.35		
.312 X	1.2 X	3.2	9900019	7.92 X	30.5 X	81

SOCKET KEY, 4 FLUTE (BRISTOL)

DIMENSIONS, INCH			PART NUMBER	DIMENSIONS, MM		
A	B	C		A	B	C
.047 X	.4 X	3.0	9900173	1.19 X	10.2 X	76
NO. 4			9900204			
NO. 5			9900066			
NO. 6			9900101			
0.76 X	.6 X	3.1	450815	1.93 X	15.2 X	79

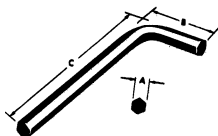

SOCKET KEY, HEX (ALLEN)

DIMENSIONS, INCH			PART NUMBER	DIMENSIONS, MM		
A	B	C		A	B	C
.028 X	.3 X	1.2	2108315	.71 X	7.6 X	30
.035 X	.3 X	1.2	452220	.89 X	7.6 X	30
.050 X	.6 X	2.9	74925	1.27 X	15.2 X	74
.050 X	.6 X	4.0	9900062	1.27 X	15.2 X	102
.050 X	1.7 X	4.9	460314	1.27 X	43.2 X	124
.062 X	.6 X	3.1	77009	1.57 X	15.2 X	79
.062 X	1.7 X	4.9	460313	1.57 X	43.2 X	124
• .058 X	.522 X	3.03	9900717	1.47 X	13.3 X	76.9
.077 X	1.7 X	4.9	460312	1.96 X	43.2 X	124
• .077 X	.611 X	3.22	9900716	1.96 X	15.5 X	81.8
.093 X	.8 X	3.6	450373	2.36 X	20.3 X	91
• .097 X	.689 X	3.48	9900715	2.46 X	17.5 X	88.4
.108 X	.8 X	2.2	2108490	2.74 X	20.3 X	56
.118 X	.8 X	2.7	1749238	3.0 X	23.0 X	63
.125 X	.9 X	3.9	116574	3.18 X	22.9 X	99
.140 X	1.0 X	2.5	451553	3.56 X	25.4 X	64
• .155 X	1.0 X	4.5	7231	3.94 X	25.4 X	112
.187 X	1.1 X	2.9	178397	4.75 X	27.9 X	74
.196 X	1.2 X	3.3	1749237	5.0 X	33.0 X	85
.218 X	1.2 X	3.2	450038	5.54 X	30.5 X	81
.236 X	1.4 X	3.7	1749236	6.0 X	38.0 X	96
.250 X	1.3 X	3.5	450453	6.35 X	33.0 X	89
• .312 X	1.5 X	4.0	450454	7.92 X	38.1 X	102
.375 X	1.3 X	6.7	450455	9.53 X	33.0 X	170
500 X	2.0 X	8.6	2108467	2.70 X	50.8 X	218
NO. 2			9900358			
NO. 6			9900202			
NO. 8			9900058			

• NOTE: STANDARD METRIC SIZES

# WRENCHES, KEY AND SOCKET GROUP 2

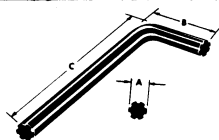





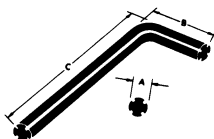













**SOCKET KEY, 6 FLUTE (BRISTOL)**





DIMENSIONS, INCH			PART NUMBER	DIMENSIONS, MM		
A	B	C		A	B	C
.047	X .6	X 4.0	9900216	1.19	X 15.2	X 102
.060	X .5	X 4.0	9900028	1.52	X 12.5	X 102
.070	X .3	X 3.1	2200051	1.78	X 7.6	X 79
.072	X .6	X 4.0	9900200	1.83	X 15.2	X 102
.094	X .3	X 3.2	2108626	2.39	X 7.6	X 81
.094	X .7	X 3.2	9900102	2.39	X 17.8	X 81
.110	X .8	X 3.6	9900103	2.79	X 20.3	X 91
.132	X .7	X 3.6	9900255	3.35	X 17.8	X 91
.143	X .9	X 2.4	450050	3.63	X 22.9	X 61
.168	X 1.0	X 4.1	452395	4.27	X 25.4	X 104
NO. 6 (.250)			9900029			
.312	X 1.2	X 3.2	9900019	7.92	X 30.5	X 81



**SOCKET KEY, 4 FLUTE (BRISTOL)**

DIMENSIONS, INCH			PART NUMBER	DIMENSIONS, MM		
A	B	C		A	B	C
.047	X .3	X 1.2	2108498	1.19	X 7.6	X 30
.047	X .4	X 3.0	9900173	1.19	X 10.2	X 76
.090	X .5	X 3.2	112646	2.29	X 12.7	X 81
.109	X .6	X 2.0	123789	2.77	X 15.2	X 51
.131	X .7	X 3.7	152857	3.33	X 17.8	X 94
NO. 4			9900204			
NO. 5			9900066			
NO. 6			9900101			
.077			450815			

HEX WRENCHES			SPLINED WRENCHES, 6 FLUTE		
	3/16"	178397		5/16"	9900019
	5/32"	9900339		1/4"	9900029
	9/64"	451553		#133	9900255
	1/8"	116574		#10	9900103
	7/64"	2108490		#8	9900102
	3/32"	450373		#6	9900200
	#8	9900058		#4	9900028
	#6	9900202		#2	9900216
	#4	9900062			
	#2	9900358			

SPLINED WRENCHES, 4 FLUTE		
	5/64"	450815
	#6	9900101
	#5	9900066
	#4	9900204
	#2	9900173

**SPLINED WRENCH BM 9900610  
CONSISTING OF**

4 - 9900200 #6 6 FLUTE

3 - 9900028 #4 6 FLUTE

2 - 9900216 #2 6 FLUTE



SOCKET WRENCH COMPARISON CHART

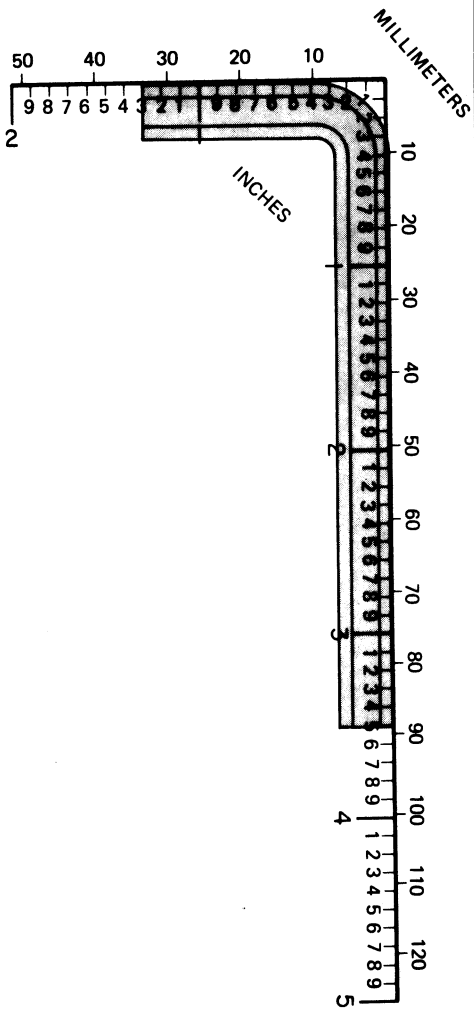

**GROUP 3**

**HAMMERS AND SCREWDRIVERS**

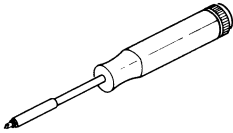

**9900712 SCREWDRIVER,  
MAGNETIC TIP 4 IN.  
BLADE, 1/4 IN. BITS**

**SCREWDRIVER BITS**  
9900720 NO. 1 PHILLIPS  
9900721 NO. 2 PHILLIPS  
9900722 SMALL SLOTTED  
9900723 LARGE SLOTTED

**NOT INCLUDED WITH  
9900712**  
9900766 NO. 1 SUPADRIVE®  
9900767 NO. 2 SUPADRIVE®

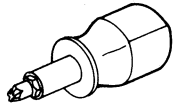

**9900713 SCREWDRIVER,  
MAGNETIC TIP 1.45  
IN. BLADE**  
9900721 BIT, PHILLIPS NO. 2

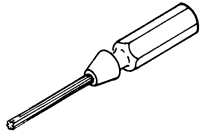

**9900608 SCREWDRIVER, 6  
FLUTE, NO. 6 BIT**  
9900040 SCREWDRIVER,  
6 FLUTE, NO. 8 BIT



**9900609 REPLACEMENT BIT,  
6 FLUTE, NO. 6**  
9900041 REPLACEMENT BIT,  
6 FLUTE, NO. 8

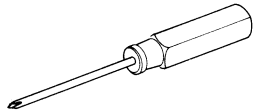

**SUPADRIVE®**  
4760541 6 IN. BLADE  
4760542 8 IN. BLADE

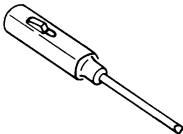

**9900070 SCREWDRIVER  
SMALL 3 IN.**

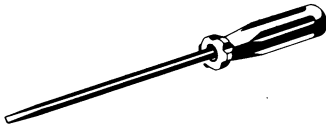

- 9900070 SCREWDRIVER SMALL 3.0 IN. WITH PALLET CLIP
- 1857020 SCREWDRIVER, 3/32 X 3 IN. BLADE
- 1650851 SCREWDRIVER, 1/8 X 4 IN. BLADE
- 1650858 REPLACEMENT BLADE, 1/8 X 4 IN.
- 1650852 SCREWDRIVER, 1/8 X 8 IN. BLADE
- 1650859 REPLACEMENT BLADE, 1/8 X 8 IN.
- 1650853 SCREWDRIVER, 3/16 X 6 IN. BLADE
- 1650860 REPLACEMENT BLADE, 3/16 X 6 IN.
- 1650857 SCREWDRIVER, 1/4 X 1-1/2 IN. BLADE (FORMERLY STUBBY)
- 1650871 REPLACEMENT BLADE, 1/4 X 1-1/2 IN.
- 1650854 SCREWDRIVER, 1/4 X 6 IN. BLADE
- 1650861 REPLACEMENT BLADE, 1/4 X 6 IN.
- 1650855 SCREWDRIVER, 1/4 X 10 IN. BLADE
- 1650862 REPLACEMENT BLADE, 1/4 X 10 IN.
- 1650856 SCREWDRIVER, 5/16 X 8 IN. BLADE (ROUND SHAFT WITH BOLSTER)
- 1650863 REPLACEMENT BLADE, 5/16 X 6 IN.
- 1857019 SCREWDRIVER, 3/16 X 3 IN BLADE
- 8549394 SCREWDRIVER, 5/16 X 9 IN. BLADE (SQUARE SHANK)

\*SNAP-ON® TOOLS ARE WARRANTED FOR LIFE TIME USE

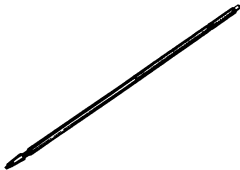

SCREW STARTER

- 9900328 LARGE
- 9900060 SMALL

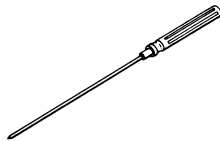

- 9900212 SCREW STARTER, HAND QUICK WEDGE 8-1/2 IN.

# HAMMERS AND SCREWDRIVERS

GROUP 3

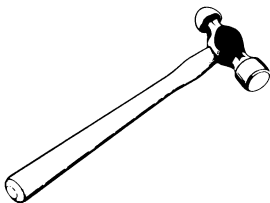

**HAMMER, BALL PEEN**

- 9900076 2 OZ, 56 GR
- 1650874 4 OZ, 112 GR  
10-1/2 IN. HANDLE
- 1650875 8 OZ, 224 GR  
12-1/2 IN. HANDLE
- 450571 24 OZ, 672 GR

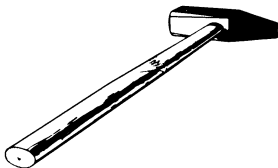

**HAMMER, FLAT PEEN**

- \*489036 5 OZ, 150 GR
- \*489982 7 OZ, 200 GR

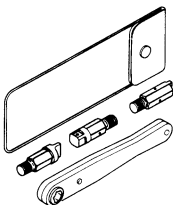

**451135 KIT ASM, RATCHET  
SCREWDRIVER  
CONSISTING OF**

- 1650758 SCREW ADAPTER  
3/16 IN.**
- 451130 SCREW ADAPTER 1/4  
IN.**
- 451131 SCREW ADAPTER 3/8  
IN.**
- 451132 DRIVE 1/4 IN. SQ.**
- 451133 HANDLE**
- 451134 CASE, PLASTIC**

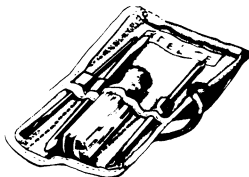

**460258 SCREWDRIVER KIT,  
PHILLIPS AND STD.**

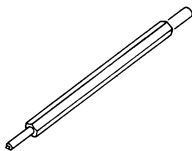

**1864853 ADJUSTING TOOL,  
MINI-POT**

**GROUP 3**      **HAMMERS AND SCREWDRIVERS**

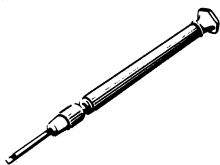

**461228 JEWELER  
SCREWDRIVER ASM**



**\*8021710 SCREWDRIVER**

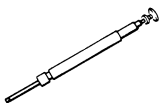

**9900361 JEWELER SCREWDRIVER  
SMALL  
9900363 REPLACEMENT  
BLADE**

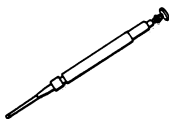

**9900362 JEWELER SCREWDRIVER  
LARGE  
9900364 REPLACEMENT  
BLADE**

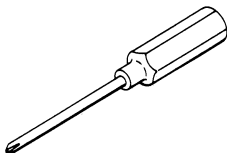

**2197195 PHILLIPS HEAD  
SCREWDRIVER NO. 2**



**\*489146 SCREWDRIVER**

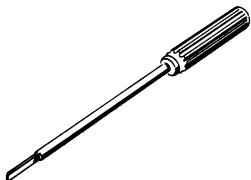

**2108766 SCREWDRIVER  
ALIGNMENT TOOL**

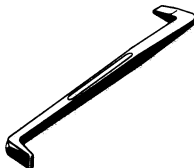

**\*489136 SCREWDRIVER,  
OFFSET**

**HAMMERS AND SCREWDRIVERS**      **GROUP 3**



**460811 SCREWDRIVER,  
ALIGNMENT, FIBER  
PROBE**



**\*4261079 SCREWDRIVER  
INSERT, HYDRAULIC  
1311**



**9900337 SCREWSTARTER  
QUICK WEDGE 6 IN.  
BLADE**

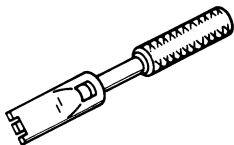

**9900686 SCREWSTARTER  
2 1/2 IN.**

**GROUP 3**

**HAMMERS AND SCREWDRIVERS**

**NOTES:**

(

(

(

(

(

(

(

## PLIERS AND TWEEZERS



1650866 PLIERS, LONG NOSE,  
ROUND 6 IN.  
SNAP-ON® TOOLS ARE  
WARRANTED FOR LIFE  
TIME USE



460808 PLIERS, LONG NOSE,  
8 IN.



450786 PLIERS, JEWELERS,  
CHAIN NOSE, 4-1/2  
IN.

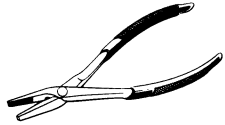

1650864 PLIERS, DUCK BILL,  
8 IN.

SNAP-ON® TOOLS ARE  
WARRANTED FOR LIFE  
TIME USE



452368 SCISSOR, CLAMP  
CURVED TIP  
9900233 SCISSOR, CLAMP  
STRAIGHT TIP



1650865 PLIERS, DIAGONAL  
CUTTING  
FLUSH-CUT  
(USE FOR SOFT  
WIRE ONLY)  
9900688 PLIERS, DIAGONAL  
CUTTING, 4 IN.  
SEMI FLUSH CUT  
(WILL CUT SPRINGS)

SNAP-ON® TOOLS ARE  
WARRANTED FOR LIFE  
TIME USE



9900064 PLIERS, GAS



**GROUP 4**

**PLIERS AND TWEEZERS**

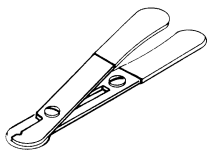

**450694 WIRE STRIPPER,  
16-26 AWG**

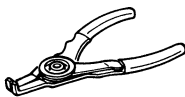

**9900317 PLIERS, GRIP RING -  
SMALL  
9900714 PLIERS, GRIP RING -  
LARGE**

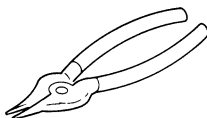

**1864854 PLIERS, RETAINING  
RING, ST. TIPS  
(REVERSIBLE)**

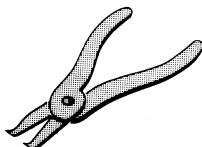

**460622 PLIERS, RETAINING  
RING, BENT TIPS,  
INT.**

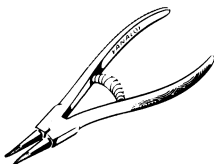

**\*489967 PLIERS, RETAINING  
CLIP**



**489969 PLIERS, RETAINING  
CLIP**

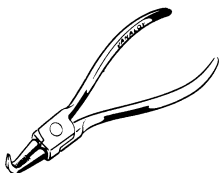

**\*489968 PLIERS, RETAINING  
CLIP**

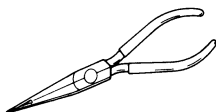

**9900521 PLIERS,  
TAPER PIN  
PULLING**

**PLIERS AND TWEEZERS**

**GROUP 4**



**460807 PLIERS, NEEDLE  
NOSE, 6-1/2 IN.,**



**\*489017 PLIERS, ADJUSTING**

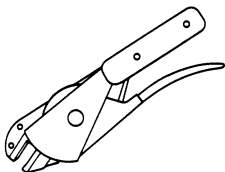

**453198 PLIERS, VISE GRIP**



**\*489905 PLIERS, POLYGRIP**



**461075 WIRE STRIPPER  
461076 STOP, WIRE  
STRIPPER—FOR  
461075**

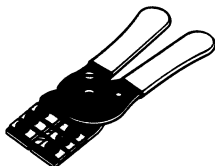

**5230092 COAXIAL CABLE  
STRIPPER**



**343641 PLIERS, BEAD  
CLOSING**

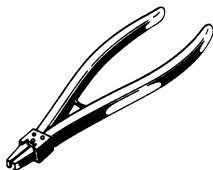

**2200101 PLIERS, GRIP  
RING 2314**

**GROUP 4**

**PLIERS AND TWEEZERS**



**461158 PLIERS, CLIP  
INSERTING—**

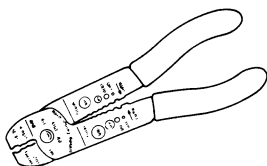

**450898 CRIMPING TOOL  
AMP 29359-1**



**461070 CRIMPING TOOL,  
AMP. 59501**

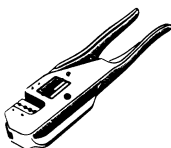

**460294 CRIMPING TOOL  
BURNDYMR 8-1A**

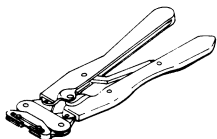

**453575 CRIMPING TOOL,  
AMP 2948-4**



**453510 CRIMPING TOOL,  
AMP 45639**

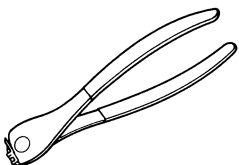

**9900268 PLIERS, PEENING**

PLIERS AND TWEEZERS

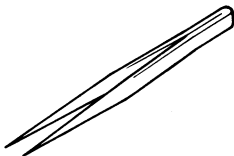

9900365 TWEEZERS



\*489242 TWEEZERS, BENT TIP



\*4261107 TWEEZERS, POINTED, INSULATED



\*489193 TWEEZERS JEWELER, INSULATED  
605904 TWEEZERS, JEWELER



2108014 TWEEZERS, SELF-CLOSING

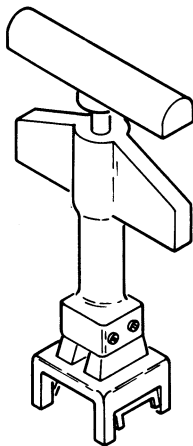

453400 EXTRACTION DEVICE. MODULE, PLUGABLE

**NOTES:**

(

(

(

(

(

(

**FILES, STONES, HACKSAWS  
AND ABRASIVES**

**GROUP 5**



**\*4351140 FILE, HAND, 6 IN.,  
TRIANGLE**



**\*4351137 FILE, HAND 6 IN.,  
HALF ROUND**

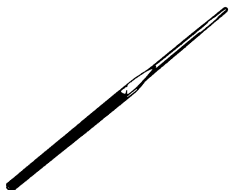

**\*4351136 FILE, HAND, 8 IN.,  
MILL**

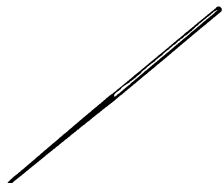

**\*4351138 FILE, HAND, 6 IN.,  
ROUND**



**\*4351141 FILE, HAND, 6 IN.,  
KNIFE**

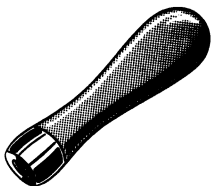

**9900007 HANDLE, FILE**

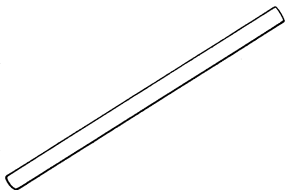

**4450567 BLADE, BURNISHING  
SILVER CONTACT**



**165866 FLEXSTONE**

**GROUP 5**

**FILES, STONES, HACKSAWS  
AND ABRASIVES**



**FILE ROUND**

- 4014 6 IN., MEDIUM
- \*4351130 6 IN., ROUGH
- \*4351049 4 IN., MEDIUM

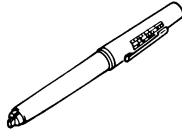

**9900360 BURNISHING TOOL  
9900359 REPLACEMENT  
BLADE**

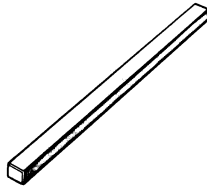

**450426 STONE, BRUSH  
SEATING**

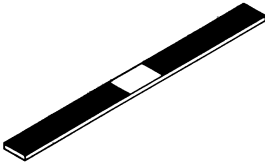

**\*489076 FILE, RELAY  
CONTACT**

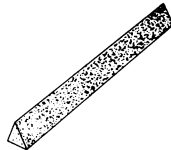

**\*4690840 OIL STONE**

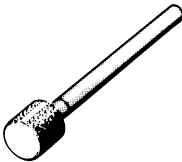

**WHEEL, ABRASIVE, SHANK**

- 450551 1 X 1-1/2 IN., 1 IN.
- 450552 1/2 X 1/2 IN.,  
1/4 IN.
- 450553 1 X 1/2 IN., 1/4 IN.

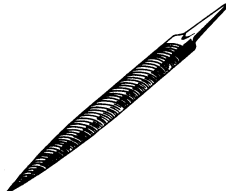

**4013 FILE, HALF ROUND 6  
IN., MEDIUM**

**FILES, STONES, HACKSAWS  
AND ABRASIVES**

**GROUP 5**

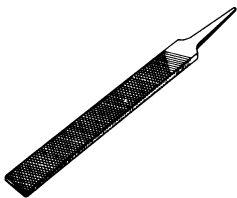

**FILE, MILL**

- 4011 6 IN., MEDIUM
- \*4351166 6 IN., ROUGH
- 18974 6 IN., PILLAR,  
MEDIUM

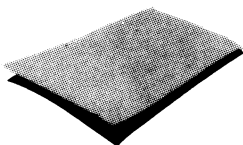

**ABRASIVE LINEN**

- 158955 ABRASIVE PAPER  
150A COARSE
- 450319 ABRASIVE CROCUS  
CLOTH POLISH
- 9900089 ABRASIVE FINE  
PAPER, 600A



**450503 STICK, EMERY  
POLISHING**

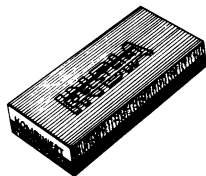

**18463 STONE,  
SHARPENING**

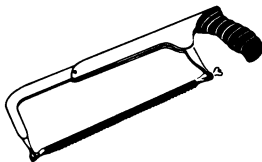

- 450155 FRAME, HAND  
HACKSAW
- 450156 BLADE, HAND  
HACKSAW 24 T, 10  
IN.
- 450157 BLADE, HAND  
HACKSAW, 32 T, 10  
IN.

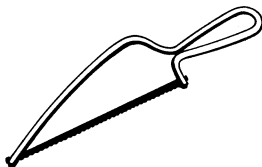

- 450432 FRAME, HAND,  
HACKSAW
- 450433 BLADE, HAND  
HACKSAW, 32 T, 6  
IN.



**GROUP 5    FILES, STONES, HACKSAWS  
                  AND ABRASIVES**

**NOTES:**

(

(

(

(

(

(

**PULLERS, EXTRACTORS, GRIPPERS,  
VISES, PUNCHES AND HOOKS** GROUP 6



**9900635 SPRING HOOK,  
HEAVY DUTY**

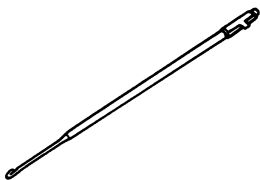

**9900210 SPRING HOOK,  
CAPTIVE**



**9900254 SPRING HOOK,  
CUSHIONED**



**450030 SPRING HOOK,  
SPECIAL**

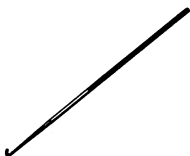

**9900105 SPRING HOOK,  
SMALL**



**9900059 SPRING HOOK,  
LARGE**



**450540 SPRING HOOK,  
SMALL CROCHET**



**171320 FINGER,  
MECHANICAL  
FLEXIBLE**

**GROUP 6 PULLERS, EXTRACTORS, GRIPPERS,  
VISES, PUNCHES AND HOOKS**



**450054 PULLER, DOWEL PIN,  
10-32 X 5-40**



**450554 PULLER, DOWEL PIN,  
T-BAR 1/4-20 NC**

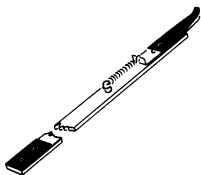

**450108 PULLER AND  
INSERTER,  
HORSESHOE CLIP**

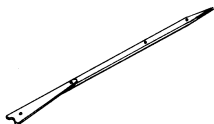

**453521 INSERT EXTRACT  
TOOL, C-CLIP**

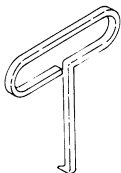

**2704117 EXTRACTOR, CARD,  
SYS 7**



**9900708 REPLACEMENT,  
TENON REMOVAL  
TOOL**

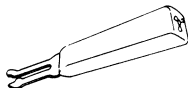

**9900612 C CLIP INSERTION  
TOOL**

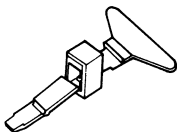

**9900709 SELECTRIC CAM  
FOLLOWER REMOVAL  
TOOL (INCLUDES  
9900708)**

**PULLERS, EXTRACTORS, GRIPPERS,  
VISES, PUNCHES AND HOOKS** **GROUP 6**



**2127892 INSERT TOOL, AMP  
CONNECTOR**

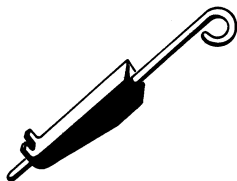

**2108493 EXTRACTOR, TAPE  
PIN, AMP  
380305-2**

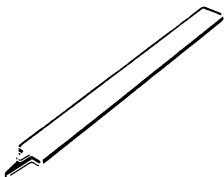

**452815 EXTRACTION TOOL,  
AMP 91017**

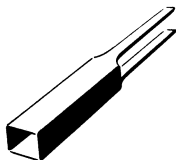

**453509 EXTRACTION TOOL,  
AMP 126056-1**

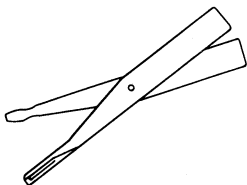

**453144 INSERT/EXTRACT  
TOOL, TROS TAPE**

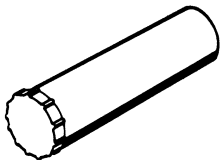

**\*489949 GRIPPER MAGNET  
489942 HULL, GRIPPER  
MAGNET**

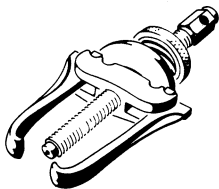

**450365 PULLER, GEAR AND  
WHEEL**

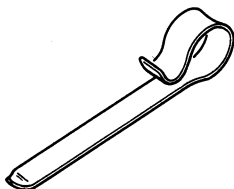

**9900206 INSERTION TOOL,  
WIRE**

**PULLERS, EXTRACTORS, GRIPPERS,  
GROUP 6 VISES, PUNCHES AND HOOKS**



**4031 PUNCH, CENTER**

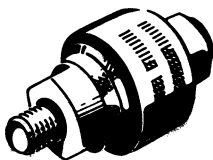

**PUNCH AND DIE, KNOCKOUT**

460139 7/8 IN. DIA  
450514 1-1/16 IN. DIA  
460169 1-3/8 IN. DIA

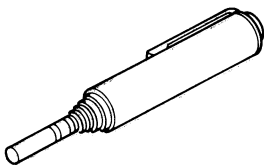

**9900727 RETRIEVER  
TELESCOPIC  
MAGNET**

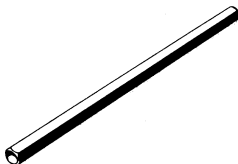

**BRASS ROD**

4047 5/16 IN. HEX X 6 IN.  
450546 3/4 IN. HEX X 20 IN.

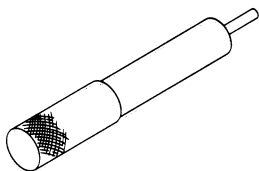

**2494907 BUSHING DRIVE, CE  
TOOL**

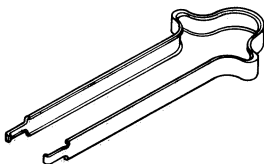

**9900764 IC MODULE  
EXTRACTING  
TOOL**

**PULLERS, EXTRACTORS, GRIPPERS, VISES, PUNCHES AND HOOKS GROUP 6**

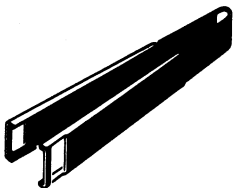

**9900373 REMOVAL TOOL  
KEYBOTTOM**

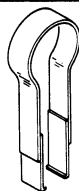

**627953 REMOVAL TOOL  
KEYTOP**



**461420 EXTRACTOR, LAMP**



**461061 EXTRACTOR, BULB**



**EXTRACTOR, TERMINAL**  
 461044 BURNDY RX 4-1  
 461043 BURNDY RX 20-10  
 461046 BURNDY RX 12-6  
 461072 BURNDY RX 16-5  
 461073 BURNDY RX 20-18  
 461060 WINCHESTER

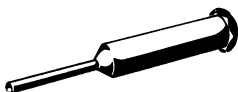

**453506 EXTRACTOR, AMP  
305141-1**  
**2108398 EXTRACTOR, PIN,  
AMP 305183**  
**9900718 EXTRACTOR, AMP  
455822-2**



**\*489019 VISE, BENCH,  
CLAMP BASE, 1.40  
IN. JAW**

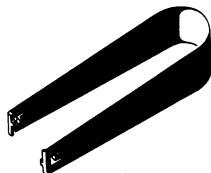

**2108860 STORAGE JUMPER  
REMOVAL TOOL**

**PULLERS, EXTRACTORS, GRIPPERS,  
GROUP 6 VISES, PUNCHES AND HOOKS**

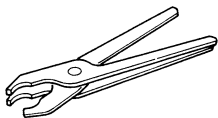

**450935 FUSE PULLER**

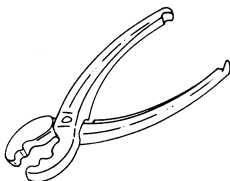

**452397 PULLER, REED RELAY  
AND FUSE**

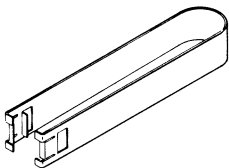

**454065 PULLER, RELAY**

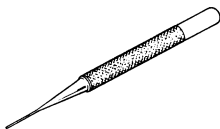

**9900084 PIN PUNCH .062 X  
4 IN.**



**PUNCH, DRIVE PIN**

- 4032 1/8 X 10 IN.
- 4035 .187 X 4 IN.
- 157198 1/4 X 8 IN.
- 157199 3/16 X 18 IN.
- 157200 3/32 X 18 IN.
- 450391 .094 X 4 IN.
- 450407 .0625 X 4 IN.
- 450448 .050 X 3-1/2 IN.
- 450456 3/32 X 8 IN. SPL
- 450457 9/32 X 8 IN. SPL
- 460303 1/8 X 8 IN. SPL
- 460315 .060 X 6 IN.
- 605908 .055 X 10.5 IN.

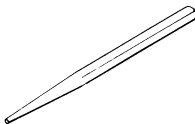

**650013 PUNCH, DRIVE PIN,  
.75 X 41 IN.  
1978459 PUNCH, ROLL PIN**

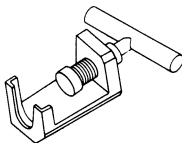

**220026 REMOVAL TOOL  
PIN 2321**

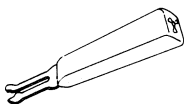

**2200103 APPLICATOR  
E-RING 2314**

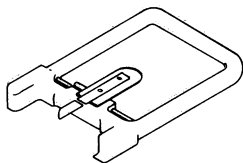

**451030 PULLER, SMS  
CARD, SINGLE**

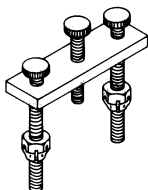

**2200205 DRUM PULL  
TOOL 2321**



**461074 EXTRACTOR,  
LAMINAR BUS  
TAPER TAB**



**460820 EXTRACTOR,  
ELECTRON TUBE**



**450626 VISE, BENCH,  
CLAMP BASE  
3 IN. JAW**

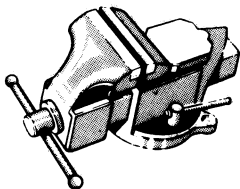

**450182 VISE, MECHANICS  
4 IN. JAW**



**451912 VISE, VACUUM  
HOLDING**



**PULLERS, EXTRACTORS, GRIPPERS,  
GROUP 6 VISES, PUNCHES AND HOOKS**

**NOTES:**

(

(

(

(

(

(

**GAUGES, ALIGNERS, ADJUSTING  
AND TIMING TOOLS**

**GROUP 7**

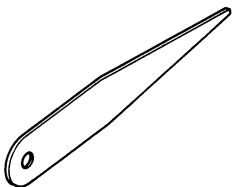

**1863715 GAUGE, FEELER .013  
IN. (0.33 MM)**



**FEELER GAUGE**

- 2536581 0.003 IN.
- 2536582 0.004
- 2536583 0.005
- 2598179 0.007
- 2598041 0.014
- 2598042 0.016

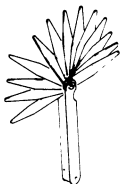

**•1749245 GAUGE, FEELER-  
METRIC .05-1.0 MM**

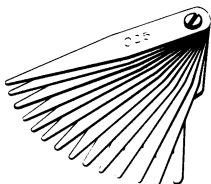

**450745 GAUGE, THICKNESS,  
.001-.030 IN.**

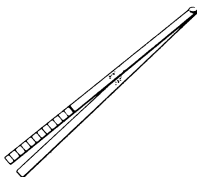

**450544 GAUGE, THICKNESS,  
.015-.020 IN.**

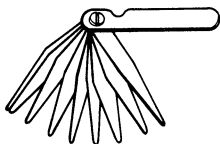

**9900468 FEELER GAUGE**

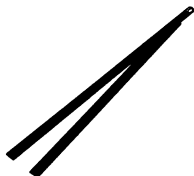

**105668 GAUGE, CHUTE  
BLADE, .0125-.018  
IN.**

**GROUP 7**      **GAUGES, ALIGNERS, ADJUSTING TOOLS,  
AND TIMING TOOLS**

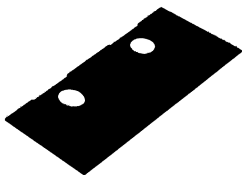

**158333 GAUGE, CARD  
HOPPER**

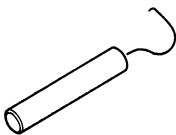

**1477925 GAUGE, DOT**

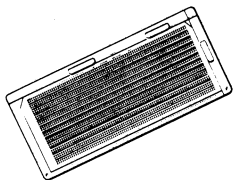

**450550 GAUGE, PUNCH  
CARD**



**9900625 GAUGE, ALIGNMENT**



**1012444 WIRE, FULCRUM  
TAB STOP**

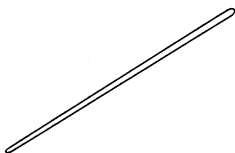

**1118213 WIRE, FULCRUM  
TYPEBAR KEYLEVER**

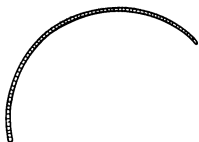

**1016718 WIRE, FULCRUM  
TYPEBAR PIVOT**

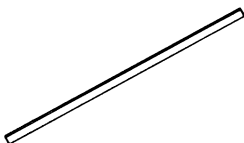

**9900379 CARBON RIBBON,  
ADJ.**

**GAUGES, ALIGNERS, ADJUSTING TOOLS,  
AND TIMING TOOLS GROUP 7**

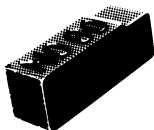

**450541 GAUGE, FEED KNIFE,  
.009 IN CARD**

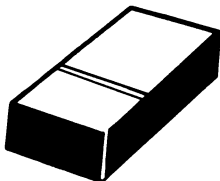

**10480 GAUGE, CARD FEED  
KNIFE, GO/NO-GO**

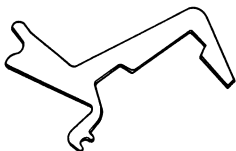

**9900519 PLATEN POSITION  
ADJ. "SELECTRIC"  
AND "SELECTRIC" II**

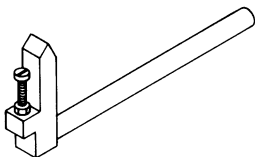

**453604 REDUCED FUNCTION  
TOOL, HALF CYCLE  
SEL I/O**

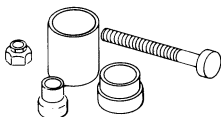

**9900523 BEARING KIT,  
CENTER  
SELECTRIC I/O**

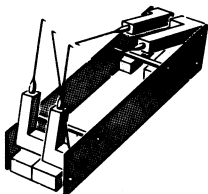

- 453523 GAUGE ASSEMBLY  
SELECTRIC I/O**
- 453524 GAUGE, WIRE—.005**
- 453525 GAUGE, WIRE—.009**
- 453526 GAUGE, WIRE—.010**
- 453527 GAUGE, WIRE—.012**
- 453528 GAUGE, WIRE—.015**
- 453530 GAUGE, WIRE—.020**
- 453531 GAUGE, WIRE—.028**

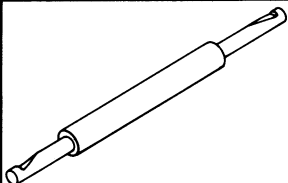

**9900253 BENDING TOOL,  
INSULATED,  
SELECTRIC I/O**

**GAUGES, ALIGNERS, ADJUSTING TOOLS,  
GROUP 7  
AND TIMING TOOLS**

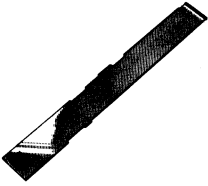

**451893 GAUGE, HAMMER  
CHAIN ALIGNMENT  
(1403)**

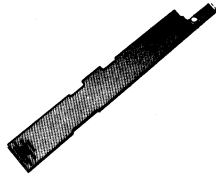

**452457 GAUGE, HAMMER  
CHAIN ALIGNMENT  
(1403/3, 1403/N1)**

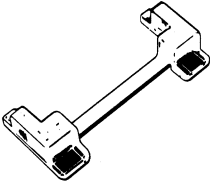

**608183 GAUGE,  
INTERMITTENT ROLL**

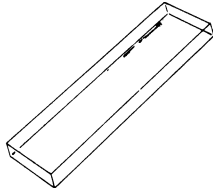

**454326 GAUGE,  
DUPLICATING  
BRUSH**

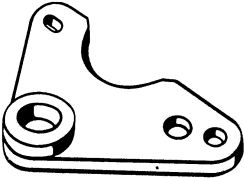

**610147 GAUGE, READER  
CLUTCH**

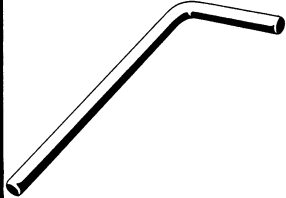

**460028 ALIGNING TOOL,  
CODE PLATE**



**9900575 HOOVEROMETER**

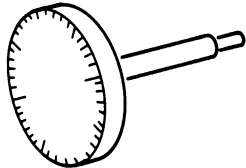

**9900427 HAND CYCLE WHEEL**

**GAUGES, ALIGNERS, ADJUSTING TOOLS,  
AND TIMING TOOLS GROUP 7**

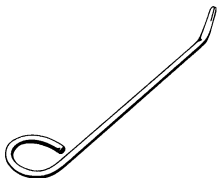

**10407 BENDING TOOL,  
CHUTE BLADE END**

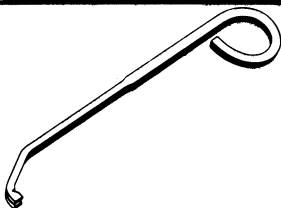

**450364 BENDING  
TOOL, BRUSH**

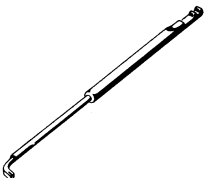

**450224 BENDING, TOOL,  
CONTACT, SELECTOR**



**\*489150 ADJUSTING TOOL,  
CONTACT SPRING**



**9900508 COMPOSER,  
VELOCITY CONTROL  
ADJ.**

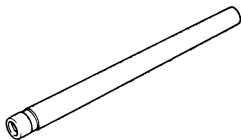

**9900601 VIEWER STREAM  
(OS6) (MICROSCOPE)  
9900685 COVERS, LENS**

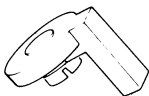

**9900633 ROTATE SELECTION  
ADJ. TOOL**



**9900533 GAUGE ELEMENT  
ESC & COMPOSER  
9900525 GAUGE ELEMENT  
EXECUTIVE MC**

**GAUGES, ALIGNERS, ADJUSTING TOOLS,  
GROUP 7  
AND TIMING TOOLS**

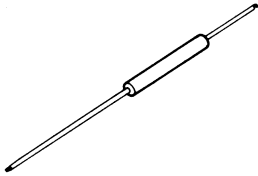

**9900505 CONTACT BENDER**

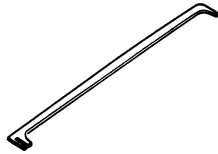

**9900092 TIP BENDER, TKO**

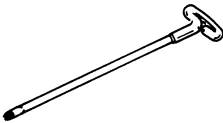

**9900094 T BENDER**

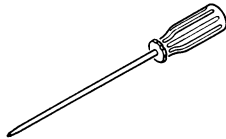

**9900626 SCREWDRIVER  
ALIGNMENT (6240)**

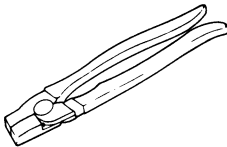

**9900589 ALIGNMENT TOOL,  
COMBINED**

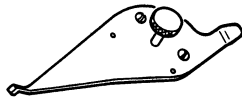

**2200698 HEAD ALIGNMENT  
TOOL**

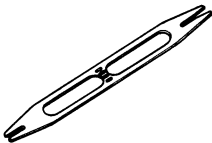

**9900093 ALIGNING WRENCH,  
TYPE**

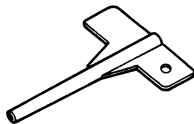

**9900627 WRENCH, HOMING  
(6240)**

**GAUGES, ALIGNERS, ADJUSTING TOOLS  
AND TIMING TOOLS**

**GROUP 7**



**9900624 PRINTWHEEL, HOMING  
PLATE (6240)**

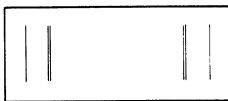

**9900510 TEMPLATE, MC  
ALIGNMENT**

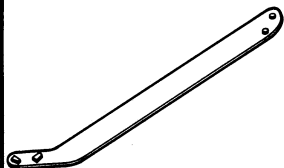

**9900730  
KEYLEVER FORMING TOOL  
SELECTRIC & TYPEBAR**



**GAUGES, ALIGNERS, ADJUSTING TOOLS  
GROUP 7  
AND TIMING TOOLS**

**NOTES:**

(  
  
(  
  
(  
  
(  
  
(  
  
(

MEASURING TOOLS (MECHANICAL) GROUP 8



152831 INDICATOR, SPEED  
ROTATION  
450574 TIP, SPEED  
INDICATOR, CONE

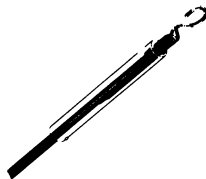

SCALE, PUSH-PULL  
460870 0-6 LB

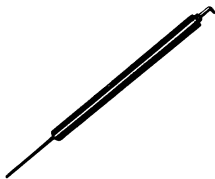

461141 SCALE, PUSH-PULL,  
0-10 LB

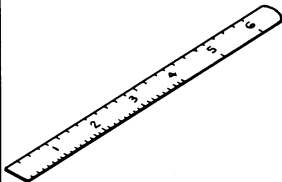

450158 SCALE, POCKET, 6  
IN.

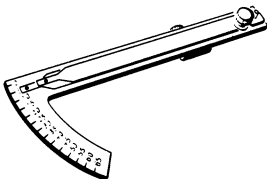

450459 SCALE ASM, GRAM  
BLADES, GRAM SCALE:

- 451914 X1
- 451916 X2
- 9900265 X5
- 451915 X10
- 451049 X20

NOTE: 450459 INCLUDES X1  
AND X10 BLADES

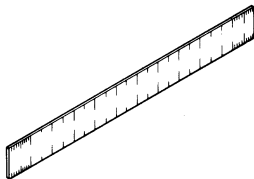

•1749246 SCALE, METRIC-  
150 MM

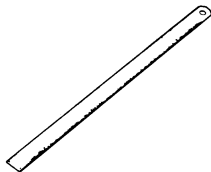

\*489185 RULER 200 MM, 8  
IN.

**GROUP 8**

**MEASURING TOOLS (MECHANICAL)**

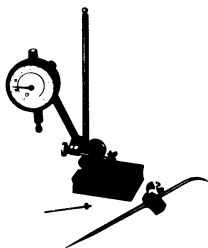

**450949 INDICATOR  
ASSEMBLY, DIAL,  
WITH STAND**  
**450948 POINT, DIAL  
INDICATOR**

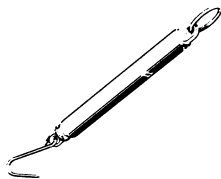

**489898 SPRING SCALE  
2.5 KG**

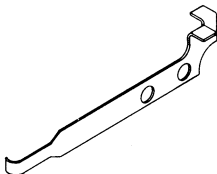

**806533 HOOK, FEED ROLL  
SPRING SCALE**

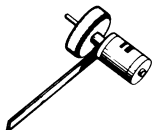

**461117 TACHOMETER  
ASM, ELECTRIC  
GENERATING**



**5258784 MANOMETER,  
PRESSURE GAUGE  
TAPE DRIVES**

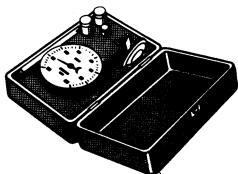

**451126 TACHOMETER  
HAND, SINGLE  
RANGE**



**2108612 GRAM GAUGE,  
0-50**

# MEASURING TOOLS (MECHANICAL) GROUP 8



- 450976 TACH. GENERATOR  
CARRIAGE  
CONSISTING OF:  
667329 TACH/GEN, SHAFT  
ADAPTER 1287  
451290 GEN. COUPLING  
1311, 1403  
451921 GEN. COUPLING  
720, 1443  
2538084 TACH. COUPLING  
5444  
2538137 TACH. BRACKET  
5444  
2600559 TACH. CAPACITOR  
5444

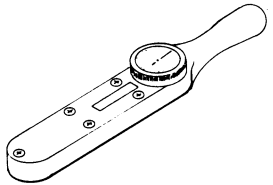

## WRENCH, TORQUE

- 2108039 3/8 IN. DR, 0-600  
IN. LB.  
2515283 3/8 IN. DR, 0-150  
IN. LB.  
2108746 ADAPTER  
3/8 IN. TO 1/4 IN.

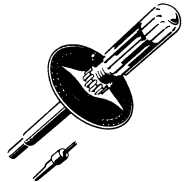

## SCREWDRIVER, TORQUE

- 461450 0-6 INCH OZ  
453570 0-48 INCH OZ  
453568 REPLACEMENT  
TIP NO. 4 SCREW  
6 FLUTE KEY

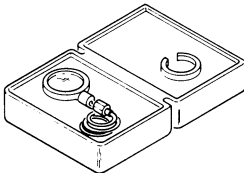

- 5495384 VACUUM/PRESSURE  
GAUGE KIT  
CONSISTING OF:  
2108312 BOX, PLASTIC  
5495385 GAUGE, 30 IN. VAC,  
80 IN. PRESSURE  
2111942 CONNECTOR, PRESSURE,  
80 IN.  
2512794 HOSE, PRESSURE,  
30 IN.  
2512088 HOSE, PRESSURE,  
8 IN.

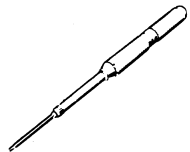

- 848204 SCREWDRIVER,  
TORQUE  
848205 BIT, SCREWDRIVER

**GROUP 8**  
**MEASURING TOOLS (MECHANICAL)**



**453539 THERMOMETER,  
 RECORDING  
 HUMIDIGRAPHS**  
**1749256 PEN, FOUNTAIN-  
 FRONT**  
**1749257 PEN, FOUNTAIN-  
 REAR**  
**1749258 INK, RED**  
**1749259 INK, BLUE**  
**1749260 CHART**

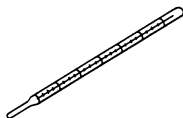

**THERMOMETER**  
**5392366 0 °F TO 120 °F**  
**1800**  
**5258786 100 °F TO 180 °F**  
**2361**

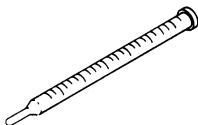

**762637 THERMOMETER,  
 MEMORY**

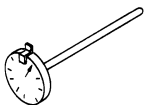

**857459 THERMOMETER, 0 °F  
 TO 220 °F**

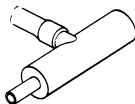

**DIVIDER AND HOSE ASM**  
**2-420 SEE T & T CEM 52**

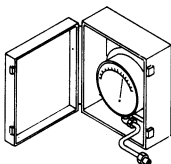

**2200040 GAUGE PNEUMATIC  
 SYSTEM**

MEASURING TOOLS (MECHANICAL) GROUP 8

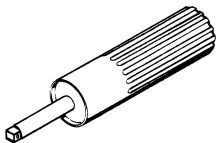

2538009 WRENCH,  
TORQUE  
ADAPTER

2598187 WRENCH, TORQUE,  
8 IN. LB.

2597969 WRENCH, TORQUE,  
4 IN. LB.

2597970 SCREWDRIVER  
ADAPTER

2597971 6 FLUTE ADAPTER  
SIZE 4-40

2286679 SCREWDRIVER  
USE WITH  
2518187

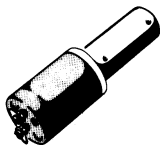

450919 TACHOMETER  
GENERATOR,  
ELECTRIC

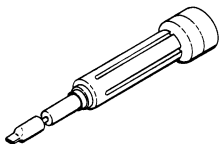

2597968 WRENCH, TORQUE  
10 IN. LB.

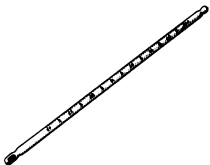

4611153 THERMOMETER

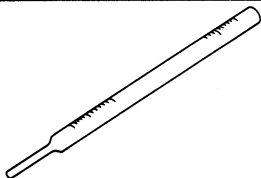

1749001 THERMOMETER  
MERCURY 30 °F  
TO 40 °F

**GROUP 8 MEASURING TOOLS (MECHANICAL)**

**NOTES:**

(

(

(

(

(

(

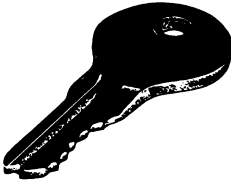

KEY, LOCK  
460108 CORBIN NO. 31

USA MANUFACTURE.  
DOES NOT MEET GERMAN  
SAFETY REGULATIONS.

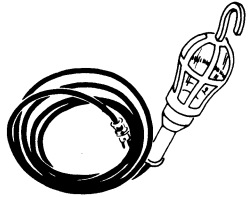

450147 LIGHT, EXTENSION



453559 BINDER, 6 RING FOR  
FE HANDBOOKS

GERMAN MANUFACTURE  
MEETS GERMAN SAFETY  
REQUIREMENTS

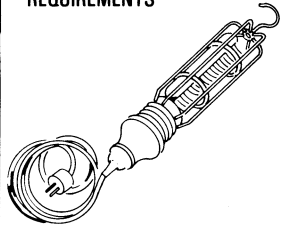

4261124 LIGHT, EXTENSION  
4116511 BULB, 110V, 25W  
4116650 BULB, 220V, 25W



453518 LAMP, MAGNETIC  
BASE, 110 VAC  
2728186 REPLACEMENT BULB  
WILL NOT FIT  
SHROUDED OUTLETS

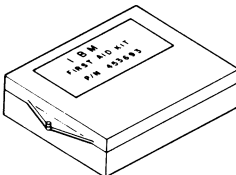

453693 FIRST AID KIT  
9900081 FIRST AID KIT,  
SMALL

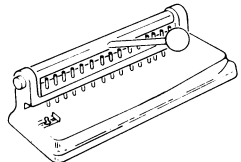

512893 PERFORATOR, PAPER,  
DESK, 22-HOLES  
5373499 REPLACEMENT  
HANDLE



**GROUP 9**

**MISCELLANEOUS TOOLS**

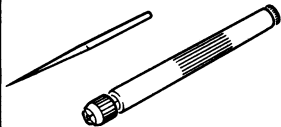

450022 SCRIBER, HOLDER  
ASSEMBLY  
176088 SCRIBER POINT,  
REPLACEMENT

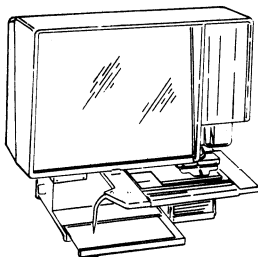

**INFORMATION ONLY  
NO LONGER AVAILABLE  
1650949 VIEWER,  
MICROFICHE**



1762907 VIEWER, MICROFICHE,  
PORTABLE  
1851996 LAMP

1650768 LENS, "D"  
1644014 LENS, "G"  
1650798 LAMP, EPX  
1748975 LAMP, FDS

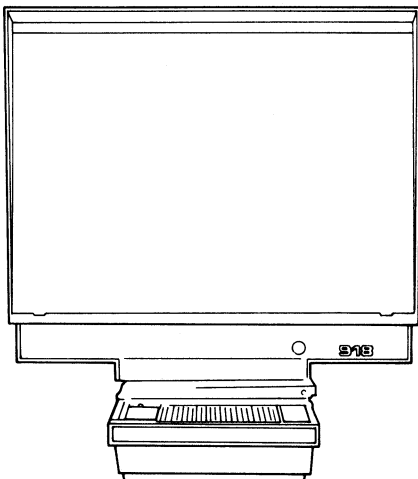

1641126 VIEWER MICROFICHE  
6428890 LAMP

MISCELLANEOUS TOOLS

GROUP 9

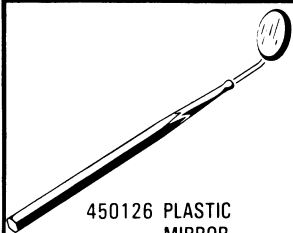

450126 PLASTIC MIRROR, DENTAL

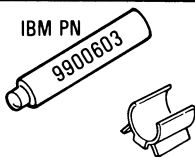

IBM PN  
9900603  
9900604

DISPOSABLE FLASHLIGHT HEAVY DUTY  
MAGNETIC CLIP

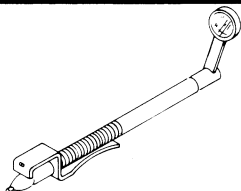

452642 MAGNIFIER, LIGHTED  
453404 BULB

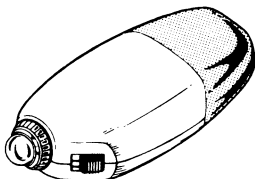

\*4261076 FLASHLIGHT

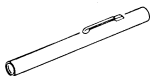

9900585 DISPOSABLE FLASHLIGHT  
REPLACEMENT BATTERIES MAY BE PRUCHASED LOCALLY

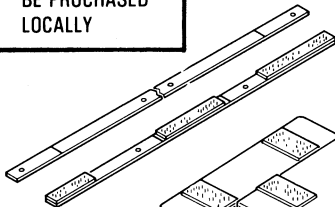
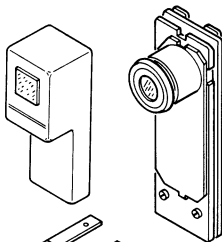

1857009 VIEWER  
1851976 VIEW CASE  
1851978 MICROFICHE CASE  
1851977 STRAP

**GROUP 9**

**MISCELLANEOUS TOOLS**

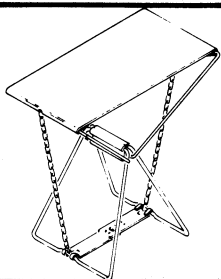

6339648 FOLDING SEAT



**CLEANING TOOLS, BRUSHES GROUP 10**

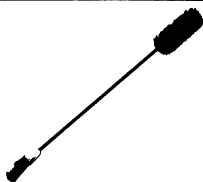

**9900719 BRUSH, SOFT  
450732 BRUSH, SASH, TOOL  
BAG  
3701 BRUSH, RED HANDLE**

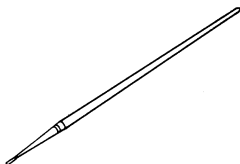

**451555 BRUSH, CLEANING  
PHOTOCELL LAMP**



**9900014 BRUSH, OIL**



**453536 BRUSH,  
TYPE CLEANING**

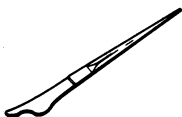

**9900004 SEGMENT PICK**

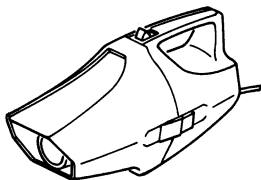

**NOT FOR COPIER USE**

**1646825 VACUUM CLEANER  
1646826 REPLACEMENT  
BAG'S  
1646827 CARRYING CASE  
8549392 HOSE**

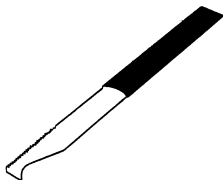

**3339 CLEANER, CHUTE  
BLADE  
961343 CARD SAW 129**

**FOR COPIER  
APPLICATION USE  
9900735**

**GROUP 10    CLEANING TOOLS, BRUSHES**

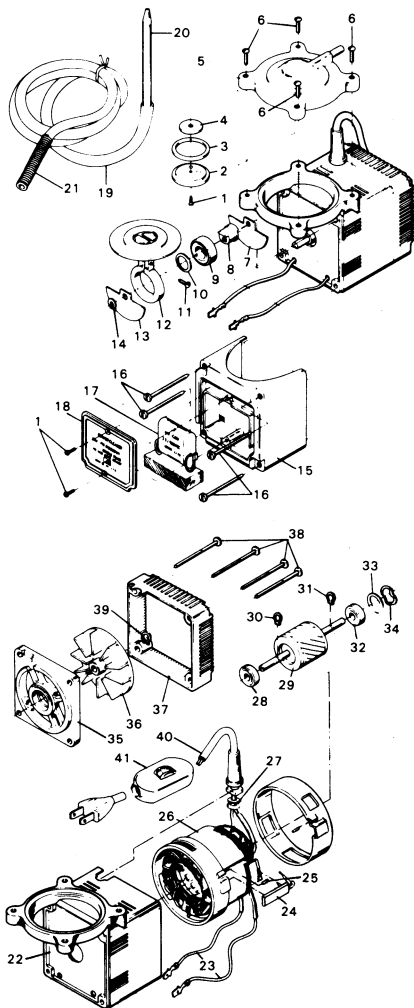

**9900534 POWER CLEANER, COMPLETE  
CONSISTING OF**

- 1 9900562 SCREW
- 2 9900539 PLATE, VALVE
- 3 9900538 GASKET
- 4 9900537 VALVE
- 5 9900536 PUMPHEAD
- 6 9900561 SCREW
- 7 9900543 COUNTERWEIGHT
- 8 9900541 ECCENTRIC
- 9 9900542 BEARING
- 10 9900567 WASHER
- 11 9900563 SCREW
- 12 9900568 CRANK ASM
- 13 9900543 COUNTERWEIGHT
- 14 9900551 GRIP RING
- 15 9900554 COVER
- 16 9900565 SCREW
- 17 9900556 CAPACITOR
- 18 9900555 COVER,CAPACITOR
- 19 9900560 HOSE
- 20 9900559 NOZZLE
- 21 9900574 SPRING
- 22 9900535 COVER, MOTOR
- 23 9900573 WIRE ASSEMBLY
- 24 9900572 PIN, MOTOR
- 25 9900545 STATOR
- 26 9900558 GROMMET
- 27 9900546 BEARING
- 28 9900544 ARMATURE
- 29 9900549 GRIP RING
- 30 9900550 GRIP RING
- 31 9900547 BEARING
- 32 9900540 SPACER, AS NEEDED 1 REQ.
- 33 9900548 SPRING WASHER
- 34 9900569 BEARING SUPPORT
- 35 9900566 FAN
- 36 9900552 FAN COVER
- 37 9900564 SCREW
- 38 9900551 GRIPPING
- 39 9900553 CORD & SWITCH
- 40 9900570 SWITCH

**GROUP 10**

**CLEANING TOOLS, BRUSHES**

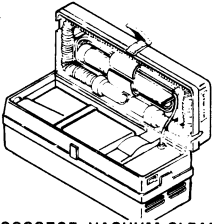

**9900735 VACUUM CLEANER  
(COPIER)**

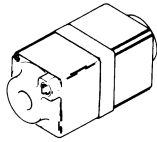

**9900736 FILTER (FOR USE WITH  
9900735)**

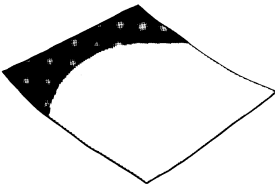

**CLOTH**

- 9900724 COPIER DRUM**
- 2108930 LINTFREE, PACK OF 10**
- \*4098027 COLORED, KG**
- \*4691431 LINEN, KG**
- 1477753 LINTFREE CLOTHS, BOX OF 50**

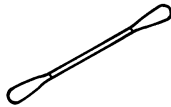

**1244747 Q-TIPS PACKAGE OF 100**

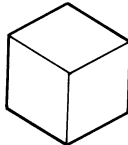

**9900734 FOAM CLEANING CUBES**

**FOR CLEANING SELECTRIC RIBBON MECHANISM**

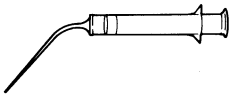

**1477752 SYRINGE (056)**

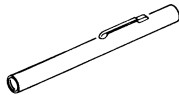

**1294241 COPIER**

**HOT ROLL CLEANING PEN**

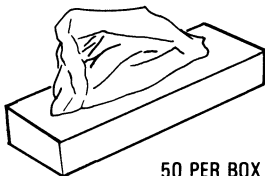

50 PER BOX

1650800 RAGS  
THE FOLLOWING MACHINE  
TYPES STILL REQUIRE P/N  
2108930 LINT FREE CLOTH:  
2301, 2302, 2321, 24XX,  
34XX and 3800

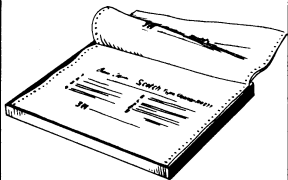

451529 TYPE CLEANER,  
SCOTCH



2123106 KIMWIPES  
15 X 17-5/8 IN.

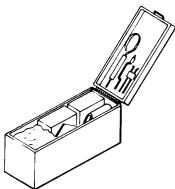

352465 KIT ASM, TAPE CLEANER  
CONSISTING OF

- 352466 BOX, CLEANER
- 352561 DECAL, CLEANING INSTRUCTION
- 352605 FELT PADS PACKAGE
- 352606 PAD HOLDER
  
- 556945 BRUSH, CLEANER, 2½ IN. NYLON
- 453536 BRUSH, TAPE CLEANING
- 2108930 CLOTH, LINT FREE 9 IN. X 9 IN.
- 2507587 PROBE, 1/8 IN. X 4½ IN. NYLON
- 2513590 BRUSH, TAPE PATH CLEANING

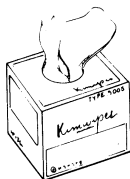

2162567 KIMWIPES  
5 X 8-3/4 IN.

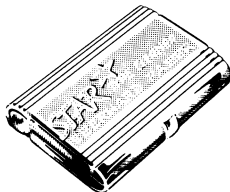

450528 TYPE CLEANER



**GROUP 11 OILERS AND GREASE GUNS**

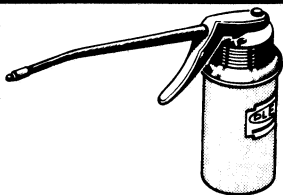

**153778 OILER, HAND, 6 OZ,  
PISTOL  
450014 NOZZLE**

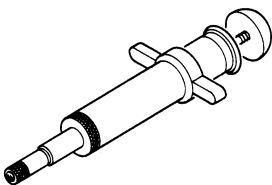

**1749267 GREASE GUN**

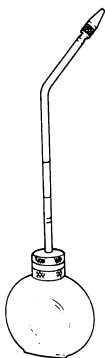

**450713 OILER, HAND  
RESERVOIR 1/2 OZ.  
9900374 REPLACEMENT  
SPOUT, LONG  
9900108 RESERVOIR 1 OZ.**

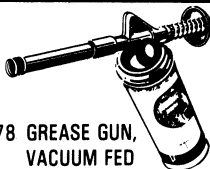

**9900578 GREASE GUN,  
VACUUM FED  
1864856 GREASE GUN—  
SPRING LOADED  
9900271 NOZZLE, SHORT  
450813 NOZZLE, LONG**



**450566 EXTENSION, GREASE  
NOZZLE TIP FOR  
1864856**

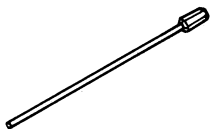

**450443 OILER EXTENSION,  
FLEXIBLE FOR  
153778**



**\*4261101 OIL DROPPER**



4055 SOLDERING FLUX,  
PASTE



2102025 SOLDER, LEAD/TIN  
ALLOY, WW ROSIN  
.062 DIA

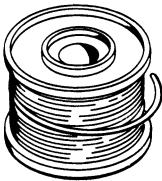

5151439 SOLDER WICK

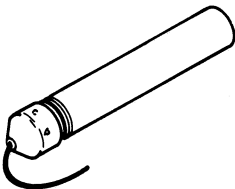

9900026 SOLDER

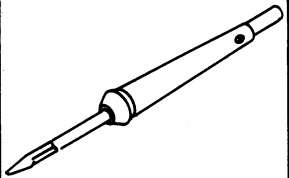

- \*489881 SOLDERING IRON,  
16 W 200 V
- \*489882 SOLDERING IRON,  
16 W
- \*489883 TIP, REPLACEABLE



454332 SOLDERING IRON  
HANDLE AND CORD  
SET, 110 V

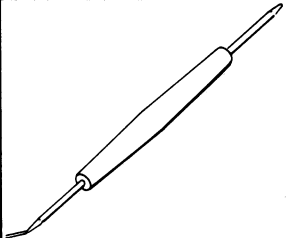

5230032 SOLDERING AID

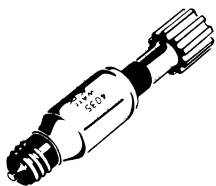

460194 HEATING ELEMENT  
110 V, FOR 454332

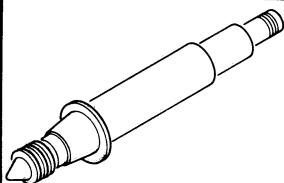

1650786 HEATING ELEMENT  
FOR 454332

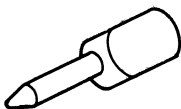

1650787 SOLDERING TIP,  
PENCIL 1/8 IN.



1650788 SOLDERING TIP,  
PYRAMID 5/16 IN.



9900016 SOLDERING TIP 50  
WATT COMPLETE  
FOR 454332

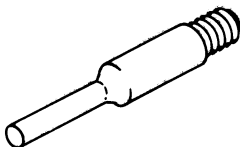

9900381 SOLDER ELEMENT  
27 WATT  
9900382 TIP FOR 9900381

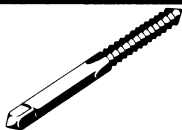

## TAP THREADING - INCH

55746	2-56	UNC
55747	3-48	UNC
4006	4-36	UNS
55748	4-40	UNC
4007	5-40	UNC
4008	6-32	UNC
55750	6-40	UNF
4009	8-32	UNC
55753	8-40	UNS
55754	10-24	UNC
55755	10-30	UNS
4010	10-32	UNF
55757	12-24	UNC
450171	14-24	UNS
450172	1/4-20	UNC
55759	1/4-24	UNS
450273	1/4-28	UNF
55761	5/16-18	UNC
55760	5/16-24	UNF
450288	5/16-32	UNS
450336	3/8-16	UNC
450422	3/8-24	UNF

## METRIC TAPS

SIZE OF TAP	TAP DRILL	BODY DRILL	TAP PART NO
M2 X 0.4	52	47	1749288
M2.5 X 0.45	46	40	1749289
M3 X 0.5	40	31	1749290
M3.5 X 0.6	33	29	1749291
M4 X 0.7	30	22	1749292
M5 X 0.8	19	9	1749293
M6 X 1.0	9	15/64	1749294
M8 X 1.25	17/64	5/16	1749295

UNC - Coarse Thread

UNF - Fine Thread

UNS - Special Thread

**GROUP 13      DRILLS, REAMERS AND TAPS**



**454302 COUNTERSINK, 82  
DEG, .311 PILOT,  
1/4 SHANK**

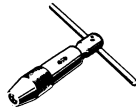

**4046 WRENCH, TAP AND  
REAMER ADJUSTABLE**

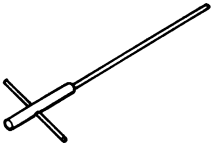

**9900605 STRIPPED  
SETSCREW  
REMOVAL TOOL**



**9900107 DRILL, CARBIDE  
TIP, NO. 36**



**1749264 DRILL, 110V 3/8 IN.  
CHUCK, VARIABLE  
SPEED, REVERSIBLE**

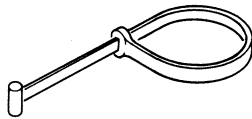

**HOLDER, CHUCK WRENCH  
NO LONGER AVAILABLE  
PURCHASE LOCAL**



450716 DRILL SET, NO. 1 THRU  
60  
CONSISTING OF

55781	1	.2280	5.79
450300	2	.2210	5.61
450272	3	.2130	5.41
450298	4	.2090	5.30
4001	5	.2055	5.22
450168	6	.2040	5.18
450277	7	.2010	5.10
4000	8	.1990	5.05
450167	9	.1960	4.98
3999	10	.1935	4.91
450301	11	.1910	4.85
3998	12	.1890	4.80
3997	13	.1850	4.70
450278	14	.1820	4.62
55771	15	.1800	4.57
450166	16	.1770	4.50
450130	17	.1730	4.39
450165	18	.1695	4.31
3996	19	.1660	4.22
55770	20	.1610	4.09
450164	21	.1590	4.04
*** 450285	22	.1570	3.99
55769	23	.1540	3.91
450287	24	.1520	3.86
450289	25	.1495	3.80
3995	26	.1470	3.73
3994	27	.1440	3.66
55767	28	.1405	3.57
450163	29	.1360	3.45
450290	30	.1285	3.26
3992	31	.1200	3.05
3991	32	.1160	2.95
*** 55786	33	.1130	2.87

## GROUP 13

## DRILLS, REAMERS AND TAPS

## DRILL SET, NO. 1 THRU 60 (CONTINUED)

450302	34	.1110	2.82
3990	35	.1100	2.79
3989	36	.1065	2.71
450162	37	.1040	2.64
450179	38	.1015	2.58
450291	39	.0995	2.53
55764	40	.0980	2.49
450263	41	.0960	2.44
450161	42	.0935	2.37
3988	43	.0890	2.26
55763	44	.0860	2.18
3987	45	.0820	2.08
450256	46	.0810	2.06
450160	47	.0785	1.99
55762	48	.0760	1.93
450159	49	.0730	1.85
450257	50	.0700	1.78
3986	51	.0670	1.70
450279	52	.0635	1.61
450262	53	.0595	1.51
450258	54	.0550	1.40
450259	55	.0520	1.32
450037	56	.0465	1.18
450299	57	.0430	1.09
450303	58	.0420	1.07
450280	59	.0410	1.04
450264	60	.0400	1.02
3993	1/8	.1250	3.18
4002	D	.2460	6.25
4003	1/4	.2500	6.35
55773	17/64	.2656	6.75
450169	15/64	.2344	5.95
450170	F	.2570	6.53

\*\*\*NOTE: REPLACEMENTS NOT AVAILABLE.  
PURCHASE LOCALLY.

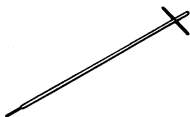

**EXTENTION TAPS**

SIZE OF TAP	TAP DRILL	BODY DRILL	TAP PART NUMBER
8-32	29	18	158220
10-32	21	10	450011
1/4-20	7	1/4	178667



**TAPS**

SIZE OF TAP	TAP DRILL	BODY DRILL	TAP PART NUMBER
2-56	49	43	55746
3-48	45	38	55747
4-40	43	32	55748
6-40	32	27	55750
10-24	25	10	55754
10-30	22	10	55755
12-24	16	2	55757
14-24	6	1/4	450171
1/4-20	7	1/4	450172
1/4-24	4	1/4	55759
1/4-28	3	1/4	450273
5/16-18	F	5/16	55761
5/16-24	17/64	5/16	55760
5/16-32	17/64	5/16	450288
3/8-16	5/16	3/8	450336
8/32	29	18	4009
6/32	7	7	4008
10/32	7	7	4010



**GROUP 13**

**DRILLS, REAMERS AND TAPS**

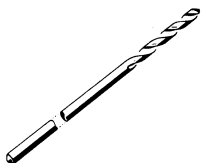

DRILL, EXTENSION		SHANK LENGTH	
154292	1/2 IN.	12.72 MM	24 IN.
450152	1/4 IN.	6.35 MM	16 IN.
450048	7/32 IN.	5.55 MM	14 IN.
178666	NO. 7		18 IN.
158799	NO. 16		9 IN.
450047	NO. 19		14 IN.
171308	NO. 20		15 IN.
154365	NO. 21		15 IN.
450236	NO. 28		14 IN.
173260	NO. 29		14 IN.

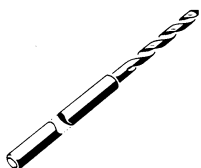

DRILL, EXTENSION		SHANK LENGTH	
173262	NO. 14		14 IN.
173261	NO. 24		14 IN.
450237	1/8 IN.	3.18 MM	14 IN.
450002	NO. 33		14 IN.
450058	NO. 37		14 IN.
167717	NO. 48		12 IN.
450253	NO. 53		3.5 IN.

# DRILLS, REAMERS AND TAPS

GROUP 13

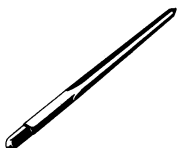

## REAMER, TAPER

8955	NO. 0
8956	NO. 1
8957	NO. 2
8958	NO. 3
450270	NO. 4
450269	NO. 5
55797	NO. 2/0
450134	NO. 3/0
55798	NO. 4/0
55799	NO. 5/0
55800	NO. 6/0
450017	NO. 7/0

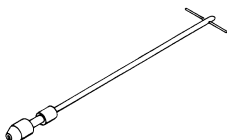

## 450529 WRENCH, TAP AND REAMER EXTENSION

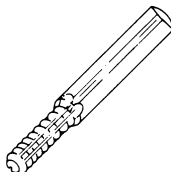

## 616185 TAP BOTTOMING 6-32

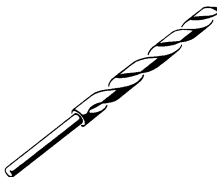

## DRILL, SHANK DIA, 1/4 IN.

450369	1/2 IN.	12.70 MM
450371	3/8 IN.	9.53 MM
450055	11/32 IN.	8.75 MM
450421	Q (.332) IN.	8.45 MM
9900077	5/16 IN.	7.95 MM

**GROUP 13**

**DRILLS, REAMERS AND TAPS**



**REAMER, HAND, T-BAR,  
TAPER, EXT.**

450008	NO. 0	12 IN.
173257	NO. 1	14 IN.
173258	NO. 2	14 IN.
173259	NO. 3	14 IN.
157919	NO. 4	12 IN.
450001	NO. 2/0	12 IN.
450057	NO. 3/0	12 IN.
167718	NO. 5/0	12 IN.



**TAP THREADING**

	INCH	EXT	MM
158220	8-32 UNC	12 IN.	4.17
450011	10-32 UNF	10 IN.	4.83
178667	1/4-20 UNC	18 IN.	6.35

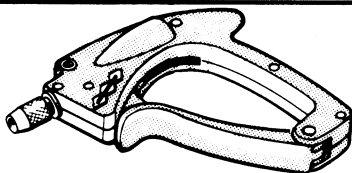

451572 WIRE WRAP TOOL,  
HAND

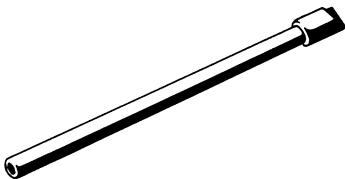

WIRE WRAP BIT

- 461011 SIZE 20 AWG
  - 461010 SIZE 22 AWG
  - 461235 SIZE 24 AWG
  - 461063 SIZE 26 AWG
  - 9263122 SIZE 30 AWG
- (FOR SLT, MST-1  
MST-2 SGL

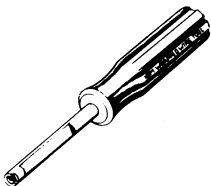

WIRE WRAP TOOL

- 451140 20-22 AWG
- 451142 24-26 AWG

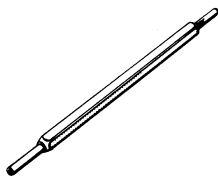

- 451573 WIRE UNWRAP  
TOOL, RH AND LH
- 452384 TIP, UNWRAP, RH
- 452385 TIP, UNWRAP, LH

**SLT/MST AND OTHER  
TECHNOLOGY TOOLS**

**GROUP 14**

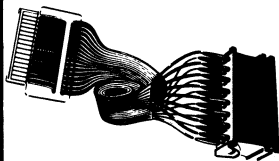

**452399 EXTENDER, CARD,  
36 IN. FLAT CABLE**

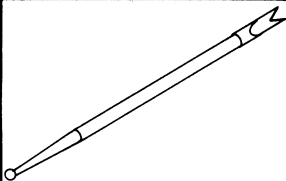

**461262 SMS BACK PANEL  
PROBE, NYLON**

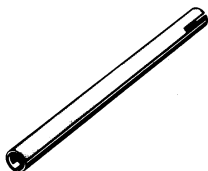

**SLEEVE, WIRE WRAP**

- 461016 SIZE 20 AWG
- 461015 SIZE 22-24 AWG
- 461014 SIZE 26 AWG
- 9328353 SIZE 30 AWG, (FOR  
SLT MST-1, MST-2  
SINGLE)

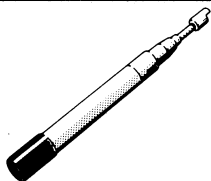

**2360355 WIRE WRAP  
EXTENSION ASM  
MST-2**

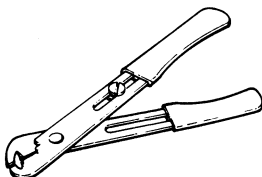

**450694 STRIPPER, WIRE**

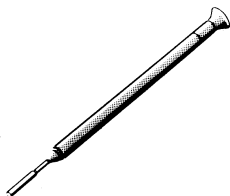

- 452527 HAND WRAP TOOL  
NO. 30**
- 452568 SLEEVE, CUTTER  
REPAIR**



**451075 EXTENDER, CARD  
AND CABLE ASM**

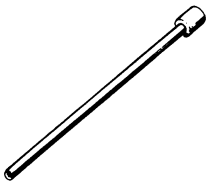

453824 EPOXY REMOVAL  
TOOL

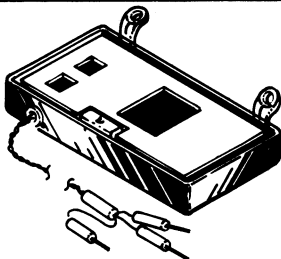

- 2728225 CARD ASM, LATCH  
MST 2-4
- 2728228 PRINTED CIRCUIT  
ASM
- 2728231 ACTIVE PROBE
- 2728246 POWER CABLE

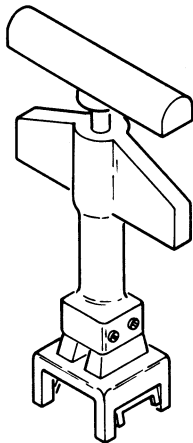

453400 EXTRACTION DEVICE  
MODULE, PLUGABLE

- 6428316 ESD KIT CONSISTING OF
- 6428275 BOX CONDUCTIVE
- 6428166 CONTROL CORD, ESD
- 6428274 MAT, ESD

◇ **NOTE: IN CASE OF FAILURE DO  
NOT REPAIR**

WRIST STRAPS MUST BE ORDERED SEPARATELY

- AR 6428167 WRIST STRAP, ESD-SMALL (FOR  
WRISTS UP TO 6 1/2"  
CIRCUMFERENCE)
- AR 6428169 WRIST STRAP, ESD-LARGE (FOR  
WRISTS OVER 6 1/2"  
CIRCUMFERENCE)

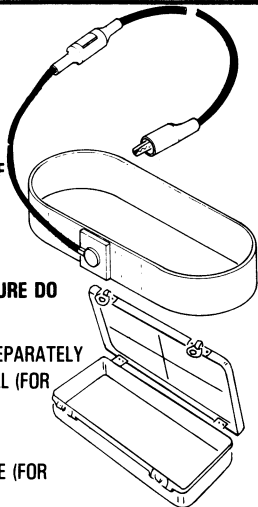

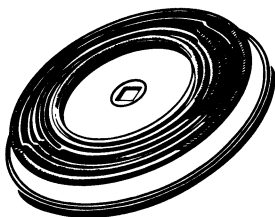

- 1264286 WIRE ROLL 100 FEET NO. 22 YELLOW**
- 815905 WIRE REEL ASM 275 FEET NO. 30 YELLOW MST-1-2**
- 815906 WIRE REEL ASM 275 FEET NO. 30 BLUE SLT**
- 815907 WIRE REEL ASM 275 FEET NO. 30 BLUE-WHITE SLT  
MST-1-2**

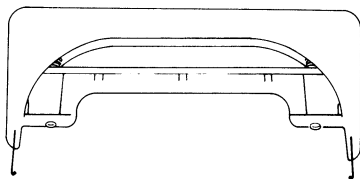

**1310707 EXTRACT TOOL**

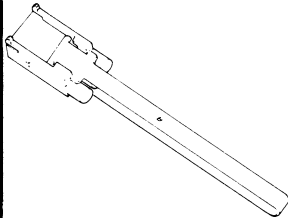

453467 INSERT/EXTRACT  
TOOL



452561 X-ACTO KNIFE

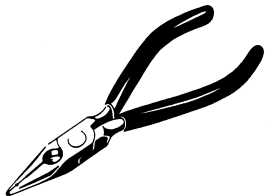

452528 PLIERS WIRE  
STRIPPER NO. 30

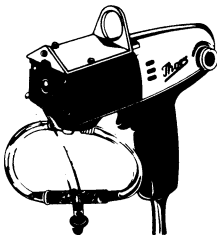

453134 POWER DELETE  
HANDLE

453063 VACUUM PUMP ASM

453085 SHAFT REDUCTION  
GEAR

453588 ADAPTER PLATE

453064 FILTER ASM

453066 RING

453067 SPONGE

453084 MOTOR ASM

453766 RECTIFIER

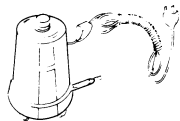

453091 VACUUM PUMP

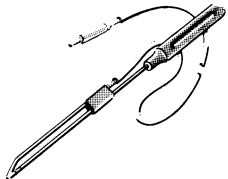

452626 DELETE TOOL, 7 IN.  
178 MM



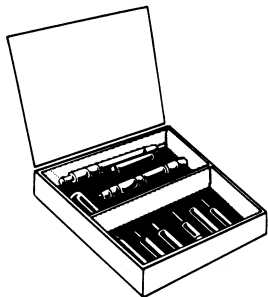

**453428 PIN REPLACEMENT  
KIT MST-SLT  
CONSISTING OF:**

- 453037 DRILL NO. 56 1.20  
MM
- 450262 DRILL NO. 53 1.50  
MM
- 451148 BOX, PLASTIC
- 452616 IMPACT TOOL
- 453390 EXTENSION
- 453443 VIAL, REPLACEMENT  
PIN, 0.515 D
- 453444 VIAL, REPLACEMENT  
PIN, 0.515 S
- 453773 REAMER 0.050 IN.
- 2108019 PIN VISE
- 452617 EMBOSING BIT
- 452618 SHORT DRIVER BIT
- 453112 LONG DRIVER BIT
- 453135 DRIFT DRIVER BIT
- 453774 DRIVER,  
REPLACEMENT PIN
- 453778 LOCATING BLOCK
- THESE TOOLS ARE FOR MST  
DOUBLE BOARDS ONLY



**453888 PROBE TIP,  
ENCAPSULATED,  
MST-2-4**

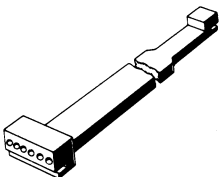

**453777 ALIGNER, GROUND  
RAIL, MST-2-4**

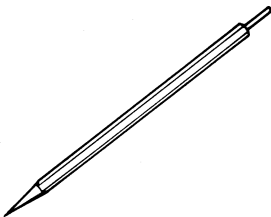

**453857 ALIGNER, PIN-SINGLE**

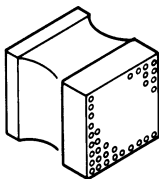

**453473 ALIGNER, PIN**

**453106 WIRE CADDY, PRE-  
CUT SIZE 30 AWG  
WIRES**

**CONSISTING OF:**

- 815094 WIRE COMPLEMENT,  
LENGTH 4.0 IN.
- 815095 WIRE COMPLEMENT,  
LENGTH 4.5 IN.
- 815096 WIRE COMPLEMENT,  
LENGTH 5.0 IN.
- 815097 WIRE COMPLEMENT,  
LENGTH 5.5 IN.
- 815098 WIRE COMPLEMENT,  
LENGTH 6.0 IN.
- 815099 WIRE COMPLEMENT,  
LENGTH 6.5 IN.
- 815100 WIRE COMPLEMENT,  
LENGTH 7.0 IN.
- 815101 WIRE COMPLEMENT,  
LENGTH 7.5 IN.
- 815102 WIRE COMPLEMENT,  
LENGTH 8.0 IN.
- 815103 WIRE COMPLEMENT,  
LENGTH 8.5 IN.
- 815104 WIRE COMPLEMENT,  
LENGTH 9.0 IN.
- 815105 WIRE COMPLEMENT,  
LENGTH 10.0 IN.
- 815106 WIRE COMPLEMENT,  
LENGTH 11.0 IN.
- 815107 WIRE COMPLEMENT,  
LENGTH 12.0 IN.
- 815108 WIRE COMPLEMENT,  
LENGTH 13.0 IN.
- 815109 WIRE COMPLEMENT,  
LENGTH 14.0 IN.
- 815110 WIRE COMPLEMENT,  
LENGTH 15.0 IN.
- 815111 WIRE COMPLEMENT,  
LENGTH 16.0 IN.
- 815112 WIRE COMPLEMENT,  
LENGTH 17.0 IN.
- 815113 WIRE COMPLEMENT,  
LENGTH 17.0 IN.  
BLUE - WHITE

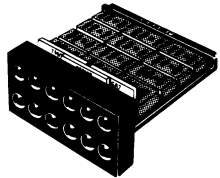
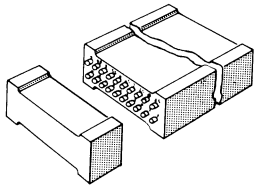

- 5803976 DISPLAY CARD, 12  
POS STAGE 1
- 5803975 DISPLAY CARD, 12  
POS STAGE 2

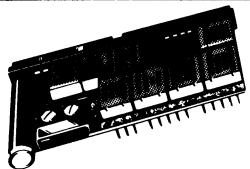

- 375277 INDICATOR CARD  
LATCH-SMS  
CARD-SMS
- 1143198 LAMP, FOR 375277
- 453618 ADAPTER, SMS  
BACK PANEL
- 5801067 INDICATOR CARD,  
LATCH-SLT  
FAST LAMP  
INDICATOR FOR  
5801358
- 5851882 INDICATOR CARD,  
LATCH-MST-1
- 5353889 LAMP FOR 5851882

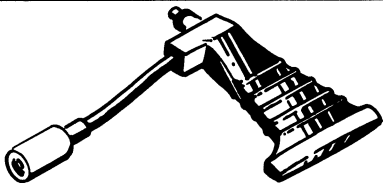

**453225 PROBE TIP SLT MST  
1-2 SGL PUSH-ON TIP**

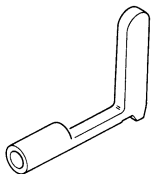

**453826 PROBE TIP ASM, SLT  
6-32**

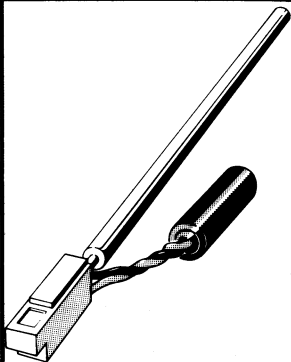

**453834 PROBE TIP ASM,  
FEMALE, ASLT MSTX**

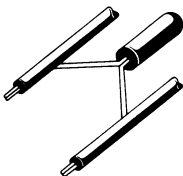

**453446 PROBE TIP, MSTX**

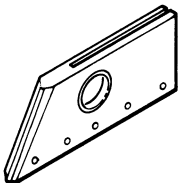

**2360383 CABLE FOLDING  
TOOL, FLAT POWER  
DIST.**

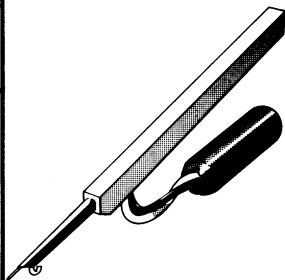

**453836 PROBE TIP ASM,  
MALE, ASLT MSTX**

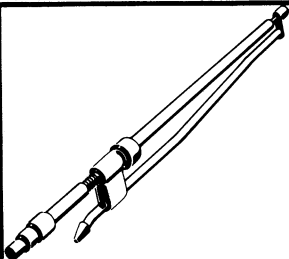

453059 DELETE FERRULE,  
SLT MST-1

74530 SET SCREW

452572 SHALLOW DELETE  
CUTTER

453061 RETAINING CLIP

453944 RETAINING RING

453461 DELETE FERRULE,  
LONG SHALLOW  
ASLT MST-2-4-X

74530 SET SCREW

452572 SHALLOW DELETE  
CUTTER

453944 RETAINING RING

453780 DELETE FERRULE,  
DEEP MST-2 DBL

74530 SET SCREW

453808 DEEP DELETE  
CUTTER

453944 RETAINING RING

453942 DELETE FERRULE  
DEEP MST-4

74530 SET SCREW

453808 DEEP DELETE  
CUTTER

453944 RETAINING RING

461556 DELETE FERRULE  
DEEP ASLT MSTX

74530 SET SCREW

453061 RETAINING CLIP

453944 RETAINING RING

461545 DEEP DELETE  
CUTTER

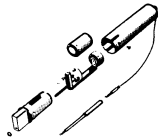

453587 CONTINUITY  
CHECKER

453119 1.35 V BATTERY

453120 2.80 V BATTERY

5353889 INDICATOR BULB

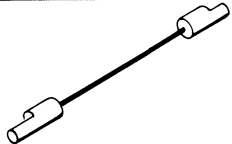

829117 JUMPER ASM, SLT 6 IN.

892118 JUMPER ASM, SLT  
18 IN.

829119 JUMPER ASM,  
2520-B

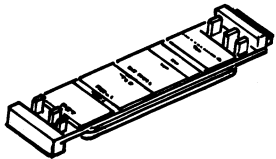

2360390 CARD EXTENDER,  
MULTI TECHNOLOGY  
1 WIDE

2360393 CARD EXTENDER,  
MULTI TECHNOLOGY  
4 WIDE

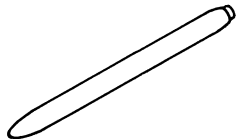

2360406 TRI-LEAD  
POSITIONING TOOL

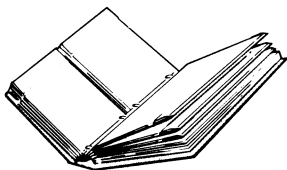
**453903 90 OHM WIRE CADDY  
CONSISTING OF:**

- 453738 90 OHM TERMINATOR, QTY 20  
453917 HOUSING, QTY 50  
2360078 WIRE CADDY 2.5 IN. 63.5 MM 90 OHM TRI-LEAD  
QTY 8  
2360000 WIRE CADDY 3.0 IN. 76.2 MM 90 OHM TRI-LEAD  
QTY 8  
2360001 WIRE CADDY 3.5 IN. 88.9 MM 90 OHM TRI-LEAD  
QTY 8  
2360002 WIRE CADDY 4.0 IN. 101.6 MM 90 OHM TRI-LEAD  
QTY 8  
2360003 WIRE CADDY 4.5 IN. 114.3 MM 90 OHM TRI-LEAD  
QTY 8  
2360004 WIRE CADDY 5.0 IN. 127.0 MM 90 OHM TRI-LEAD  
QTY 8  
2360005 WIRE CADDY 5.5 IN. 139.7 MM 90 OHM TRI-LEAD  
QTY 8  
2360006 WIRE CADDY 6.0 IN. 152.4 MM 90 OHM TRI-LEAD  
QTY 8  
2360007 WIRE CADDY 7.0 IN. 177.8 MM 90 OHM TRI-LEAD  
QTY 8  
2360008 WIRE CADDY 8.0 IN. 203.2 MM 90 OHM TRI-LEAD  
QTY 8  
2360009 WIRE CADDY 9.0 IN. 228.6 MM 90 OHM TRI-LEAD  
QTY 8  
2360010 WIRE CADDY 10.0 IN. 254.0 MM 90 OHM TRI-LEAD  
QTY 8  
2360011 WIRE CADDY 11.0 IN. 279.4 MM 90 OHM TRI-LEAD  
QTY 8  
2360012 WIRE CADDY 12.0 IN. 304.8 MM 90 OHM TRI-LEAD  
QTY 8  
2360013 WIRE CADDY 13.0 IN. 330.2 MM 90 OHM TRI-LEAD  
QTY 8

(CONTINUED)

## 90 OHM WIRE CADDY (CONTINUED)

2360014	WIRE CADDY 14.0 IN. 335.6 MM 90 OHM TRI-LEAD QTY 8
2360015	WIRE CADDY 15.0 IN. 381.0 MM 90 OHM TRI-LEAD QTY 8
2360016	WIRE CADDY 16.0 IN. 406.4 MM 90 OHM TRI-LEAD QTY 8
2360017	WIRE CADDY 17.0 IN. 431.8 MM 90 OHM TRI-LEAD QTY 12
2360018	WIRE CADDY 18.0 IN. 457.2 MM 90 OHM TRI-LEAD QTY 12
2360019	WIRE CADDY 19.0 IN. 482.6 MM 90 OHM TRI-LEAD QTY 12
2360020	WIRE CADDY 20.0 IN. 508.0 MM 90 OHM TRI-LEAD QTY 12
2360370	MID-AIR SPLICE, QTY 4

**453900 50 OHM WIRE CADDY  
CONSISTING OF:**

453917	HOUSING, QTY 50
453918	WIRE CADDY 3.0 IN. 76.2 MM 50 OHM TRI-LEAD QTY 8
453919	WIRE CADDY 3.5 IN. 88.9 MM 50 OHM TRI-LEAD QTY 8
453920	WIRE CADDY 4.0 IN. 101.6 MM 50 OHM TRI-LEAD QTY 8
453921	WIRE CADDY 4.5 IN. 114.3 MM 50 OHM TRI-LEAD QTY 8
453922	WIRE CADDY 5.0 IN. 127.0 MM 50 OHM TRI-LEAD QTY 8
453923	WIRE CADDY 5.5 IN. 139.7 MM 50 OHM TRI-LEAD QTY 8
453924	WIRE CADDY 6.0 IN. 152.4 MM 50 OHM TRI-LEAD QTY 8
453925	WIRE CADDY 7.0 IN. 177.8 MM 50 OHM TRI-LEAD QTY 8
453926	WIRE CADDY 8.0 IN. 203.2 MM 50 OHM TRI-LEAD QTY 8
453927	WIRE CADDY 9.0 IN. 228.6 MM 50 OHM TRI-LEAD QTY 8
453928	WIRE CADDY 10.0 IN. 254.0 MM 50 OHM TRI-LEAD QTY 8

(CONTINUED)

**50 OHM WIRE CADDY (CONTINUED)**

- 453929 WIRE CADDY 11.0 IN. 279.4 MM 50 OHM TRI-LEAD QTY 8
- 453930 WIRE CADDY 12.0 IN. 304.8 MM 50 OHM TRI-LEAD QTY 8
- 453931 WIRE CADDY 13.0 IN. 330.2 MM 50 OHM TRI-LEAD QTY 8
- 453932 WIRE CADDY 14.0 IN. 355.6 MM 50 OHM TRI-LEAD QTY 8
- 453933 WIRE CADDY 15.0 IN. 381.0 MM 50 OHM TRI-LEAD QTY 8
- 453934 WIRE CADDY 16.0 IN. 404.6 MM 50 OHM TRI-LEAD QTY 8
- 453935 WIRE CADDY 17.0 IN. 431.8 MM 50 OHM TRI-LEAD QTY 12
- 453936 WIRE CADDY 18.0 IN. 457.2 MM 50 OHM TRI-LEAD QTY 12
- 453937 WIRE CADDY 19.0 IN. 482.6 MM 50 OHM TRI-LEAD QTY 12
- 453938 WIRE CADDY 20.0 IN. 508.0 MM 50 OHM TRI-LEAD QTY 12
- 2360089 WIRE CADDY 2.5 IN. 63.5 MM 50 OHM TRI-LEAD QTY 8
- 2360370 MID-AIR SPLICE QTY 4

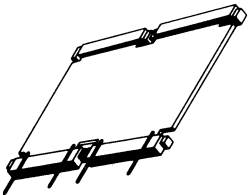

- 5853341 EXTENDER ASM  
OFFSET MST-4
- 453454 EXTENDER ASM  
MST-4
- 453740 EXTENDER ASLT  
MSTX

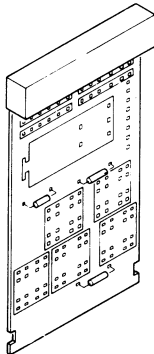

**1865015 CE LATCHED  
INDICATOR CARD**

**OSCILLOSCOPES AND ACCESSORIES,  
TEST LEADS TIPS AND CARTS GROUP 15**

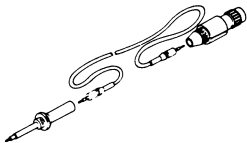

**1650776 PROBE, 10 X  
250MHZ  
CONSISTING OF  
1650761 PROBE BODY  
1650762 TWO METER CABLE  
1650778 COMPENSATION  
BOX**

**USE WITH 475 AND 454 SERIES  
SCOPES (FIELD REPAIRABLE)**

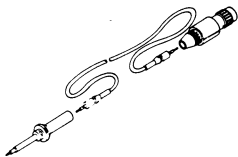

**450837 ADAPTER, COAX  
BNC TO UHF  
1650764 PROBE 10 X  
100MHZ P-6105  
CONSISTING OF  
1650761 PROBE BODY  
1650762 TWO METER CABLE  
1650763 COMPENSATION  
BOX**

**USE WITH 434 AND 465 SERIES  
SCOPES (FIELD REPAIRABLE)**

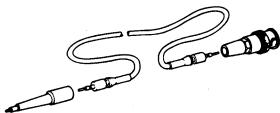

**1650767 PROBE, 1X, P-6101  
CONSISTING OF  
1650762 TWO METER CABLE  
1650765 PROBE BODY  
1650766 CONNECTOR, BNC  
(FIELD REPAIRABLE)**

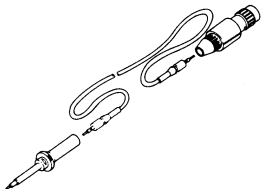

**1650882 PROBE 10 X  
100MHZ P-6108  
CONSISTING OF  
1650761 PROBE BODY  
1650762 TWO METER CABLE  
1650763 COMPENSATION  
BOX**

**USE WITH 453 SERIES SCOPES  
(FIELD REPAIRABLE)**

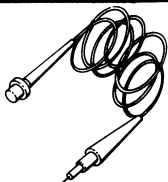

**453548 PROBE,  
OSCILLOSCOPE  
P-6034 10X**



**OSCILLOSCOPE AND ACCESSORIES,  
GROUP 15 TEST LEADS, TIPS AND CARTS**

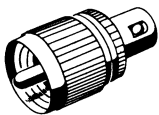

**450837 ADAPTER, COAX  
BNC TO UHF**

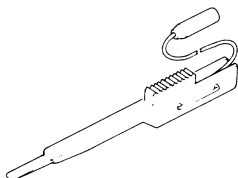

**453718 BERG MINIPROBE  
453705 BERG LATCH  
UNLATCH TOOL**



**453954 MALE COAX FEMALE  
6-32 ADAPTER**

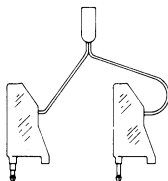

**453915 PROBE ASM.,  
GROUND AND SIGNAL**

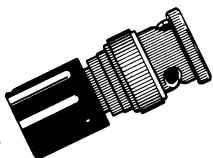

**453184 ADAPTER, BNC TO  
BINDER POST**

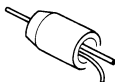

**1310714 ADAPTER  
SCOPE ACCESSORY  
TO TEST LEADS**

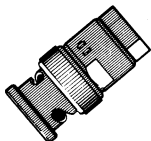

**453199 ADAPTER, PROBE  
TIP TO BNC**

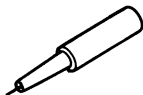

**7838680 SCOPE ACCESSORY.  
TO MINIATURE  
PROBE ADAPTER**

**OSCILLOSCOPE AND ACCESSORIES,  
TEST LEADS, TIPS AND CARTS GROUP 15**

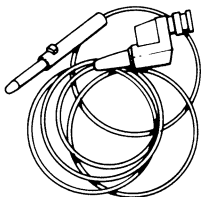

**INFORMATION ONLY  
NO LONGER AVAILABLE**

- 5500900 GROUND LEAD, 5 INCH
- 5500899 PROBE HOLDER
- 5500901 ADAPTER, 6-32
- 5500902 GROUND LEAD, 3 INCH
- 5500898 RETRACTABLE HOOK TIP
- 5495151 BODY AND SLEEVE ASM

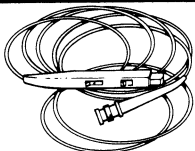

**5500903 PROBE, P6022,  
CURRENT, 9-FOOT**

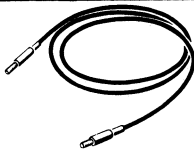

**TEST LEAD 6,6 FT, 6-32**  
4261108 RED  
4261109 GREEN

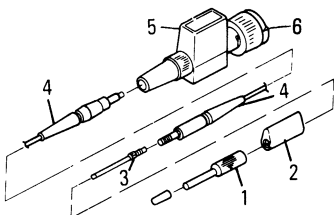

**7838679 MINIATURE PROBE 10 X 1.3 METER  
(USED WITH 2465)  
CONSISTING OF**

- 1 N/A TIP
- 2 N/A BODY SHELL
- 3 6428066 TIP ASM
- 4 6428064 CABLE ASM
- 5 N/A COMEPASION BOX
- 6 6428059 BNC CONNECTOR
- 6428114 GROUND LEAD, 20 CM. 6-32
- N/A RETRACTABLE TIP
- N/A GROUND LEAD, SHORT
- 7838680 ADAPTER MINIATURE TO SUBMINIATURE PROBE

**OSCILLOSCOPE AND ACCESSORIES,  
TEST LEADS, TIPS AND CARTS GROUP 15**

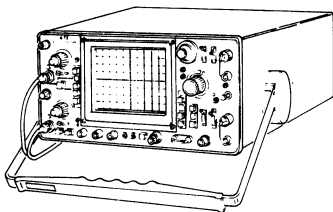

- 453550 OSCILLOSCOPE, 454A NOT AVAILABLE - REF. ONLY
- 453214 OSCILLOSCOPE HOOD, FOLDING VIEWING - 454A
- 453214 OSCILLOSCOPE, 465A INFORMATION ONLY NO LONGER AVAILABLE
- 453215 OSCILLOSCOPE, 475A INFORMATION ONLY NO LONGER AVAILABLE

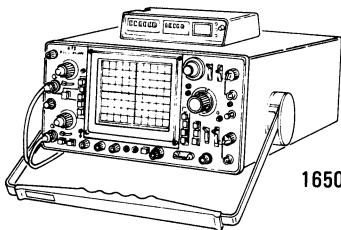

- 1650782 OSCILLOSCOPE, 475A WITH DM44 DIGITAL MULTIMETER INFORMATION ONLY NO LONGER AVAILABLE

**OSCILLOSCOPE AND ACCESSORIES,  
TEST LEADS, TIPS AND CARTS    GROUP 15**

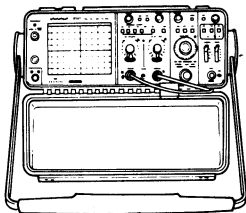

**6428880    OSCILLOSCOPE, PORTABLE  
TEKTRONIX® 2335, 100 MHZ  
(REPLACEMENT FOR 453)**

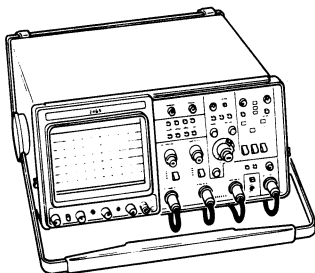

**6248881    OSCILLOSCOPE, PORTABLE  
TEKTRONIX® 2445, 150 MHZ  
(REPLACEMENT FOR 465)**

**6428882    OSCILLOSCOPE, PORTABLE  
TEKTRONIX® 2465, 300 MHZ  
(REPLACEMENT FOR 475A  
AND 475A DM44)**

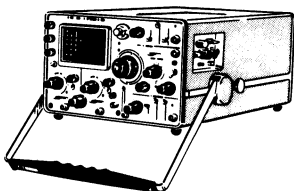
**GROUP 15****OSCILLOSCOPE AND ACCESSORIES  
TEST LEAD, TIPS AND CARTS**

- 453047 SCOPE, TEKTRONIX® 453  
NOT AVAILABLE - REF. ONLY
- 453164 ADAPTER, P 6010 TO 6-32  
THREAD
- 453167 GROUND TIP, SLT SCOPE PROBE
- 453168 GROUND LEAD, 5 IN. 127 MM
- 453178 TUBE, INSULATING, FOR  
453161
- 453179 PROBE HOLDER
- 453180 CAP, PROTECTOR, FOR 453161
- 453181 TIP, RETRACTABLE HOOK, FOR  
453161
- 453183 BAG, PLASTIC, PROBE  
ACCESSORIES
- 453184 ADAPTER, BNC TO BINDER  
POST
- 453185 POST, JACK
- 453189 RING, INSULATING, FOR  
453161
- 461090 TIP, PROBE, HOOK SHANK, 6-32
- 332009 FUSE, 2.0 AMP, 3 AG SLO-BLO
- 453194 POWER CORD, 110 V, 8 FT,  
FOR 453
- 453520 POWER CORD, 220 V, 8 FT,  
TEKT. 453
- 453201 HOOD, FOLDING VIEWING, FOR  
TEKT. 453
- 461119 TIP, PROBE, 6-32
- 461159 CLIP, ALLIGATOR, PROBE, 6-32
- 5500750 HOOD, FOLDING VIEWING 454A



453181 TIP, RETRACTABLE  
HOOK, FOR 453161  
AND 453162

461086 TIP, RETRACTABLE  
HOOK, FOR 451922  
AND 452805

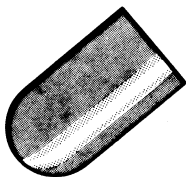

453180 CAP, PROTECTOR,  
FOR 453161 AND  
453162

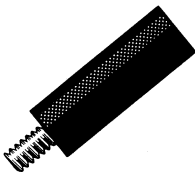

453164 ADAPTER, P6010  
TO 6-32

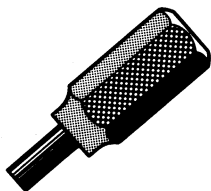

453167 TIP GROUND,  
SLT SCOPE PROBE



461091 TIP, PROBE,  
STRAIGHT SHANK,  
6-32

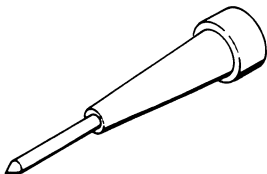

5500864 TIP, SPRING



461090 TIP, PROBE, HOOK  
SHANK, 6-32

**GROUP 15**

**OSCILLOSCOPE AND ACCESSORIES  
TEST LEAD, TIPS AND CARTS**

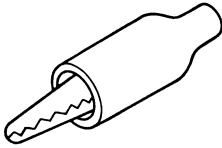

**CLIP, ALLIGATOR WITH BOOT  
6-32**

**1749251 RED  
1749255 BLACK**



**451659 TIP, BANANA  
6-32**



**461159 CLIP, ALLIGATOR  
SMALL PROBE, 6-32**

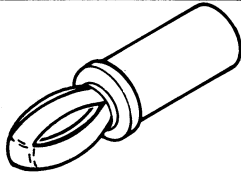

**1749247 PLUG, INSULATED  
BANANA-RED  
1749248 PLUG, INSULATED  
BANANA-BLACK**



**\*4261006 PROBE, BANANA  
PLUG CONNECTION**

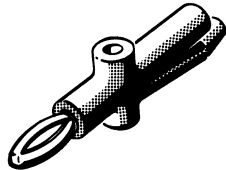

**\*4261080 COUPLING, BANANA  
PLUG, 6-32**



**461119 TIP, PROBE, 6-32**



**489806 GRABBER PROBE  
6 IN. (RED ONLY)  
REQUIRES 4261080  
COUPLING TO USE  
WITH 6-32**

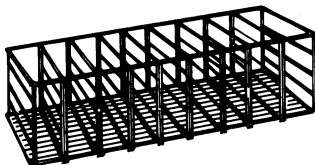

453148 CART TOP UNIT,  
8.5 X 11 BINDERS

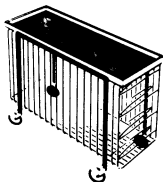

453147 CART, MANUAL  
AND SCOPE, 36 VOL.  
453154 CASTER  
453549 SOCKET  
PART NO. 453549  
CONTAINS 4 SOCKETS



453149 FRAME MANUAL B  
SIZE FOR 453147

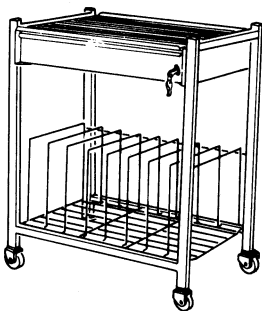

453644 CART, MINI  
1753726 BASKET, MOUNTS  
ON TOP AND HOLDS  
16 VOLUMES  
1749000 CASTER-B/M  
CONTAINS 4  
CASTERS

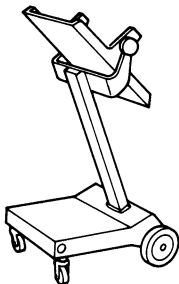

8549395 CART, SCOPE  
TEKTRONIX 200C



**GROUP 16**

**METERS, LOGIC PROBES,  
METER LEADS**

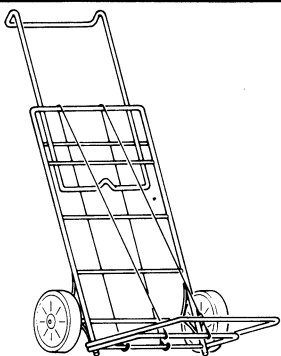

1762922 MIGHTY MINI  
CART

5997461 STRETCH CORD  
24 IN.

8549398 STRETCH CORD  
72 IN.

NO LONGER AVAILABLE  
INFORMATION ONLY

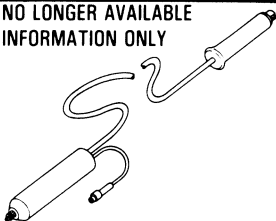

453605 CABLE, GLP  
EXTENDER



452803 NEON PROBE  
029/059

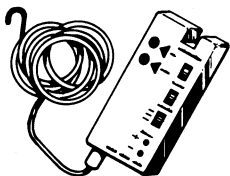

NO LONGER AVAILABLE  
INFORMATION ONLY

453212 GEN LOGIC PROBE  
(PROBE IS REPAIRED  
BY ICAR)

453826 SLT TIP

453167 SLT GROUND TIP

461091 6/32 PIN TIP

461159 ALLIGATOR CLIP

5500900 GROUND LEAD

5500901 PROBE TO 6/32 ADAP-  
TERS WITH GROUND

2588263 12 IN. SLT JUMPER

2728259 SPECIAL 12 VOLT  
JUMPER

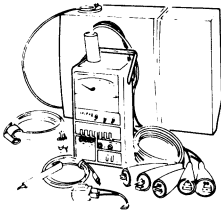

8549350 ECOS ELECTRICAL  
SAFETY ANALYZER  
CSD ONLY

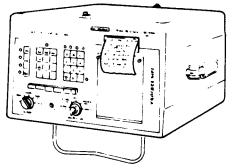

8496301 DRANETZ SERIES  
626 UNIVERSAL  
DISTURBANCE  
ANALYZER

**GROUP 16**

**METERS, LOGIC PROBES,  
METER LEADS**

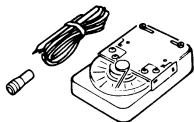

**9900167 METER, TRIPLETT  
CONTAINS  
METER LEADS  
AND BATTERIES  
ONLY**

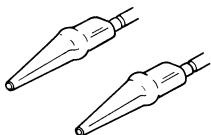

**9900729 ALLIGATOR CLIPS  
(1 PAIR)**

**FOR TRIPLETT METER**

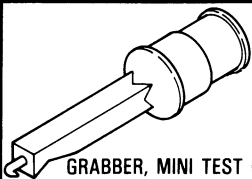

**GRABBER, MINI TEST CLIP**  
1864853 RED  
8549385 BLACK

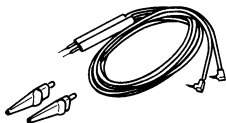

**TRIPLETT  
9900168 VOM LEADS WITH  
ALLIGATOR CLIPS**

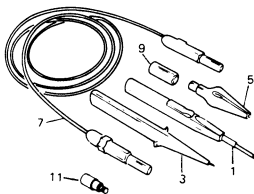
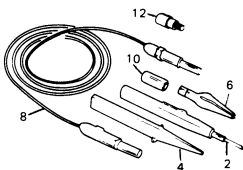

**6428104 METER LEAD SET  
CONSISTING OF**

- 1 7838682 PROBE, HOOK-RED
- 2 7838683 PROBE, HOOK-BLACK
- 3 7838684 PROBE, HIGH VOLTAGE-RED
- 4 7838685 PROBE, HIGH VOLTAGE-BLACK
- 5 7838687 ALLIGATOR CLIP-RED
- 6 7838688 ALLIGATOR CLIP-BLACK
- 7 7838689 METER LEAD-RED
- 8 7838690 METER LEAD-BLACK
- 9 7838691 ADAPTER, 6/32 IN.-RED (2)
- 10 7838692 ADAPTER, 6/32 IN.-BLACK (2)
- 11 6428110 ADAPTER, SIMPSON METER-RED
- 12 6428111 ADAPTER, SIMPSON METER-BLACK

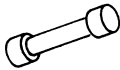

SPARE FUSES FOR TRIPLETT  
9900524 1 AMP  
9900588 1/8"

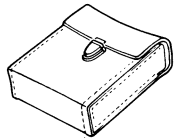

9900193 METER CASE  
TRIPLETT



9900587 BATTERY FOR  
P/N 9900167

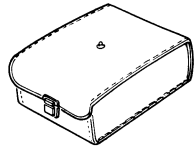

9900586 METER CASE WITH  
HOOK TRIPLETT

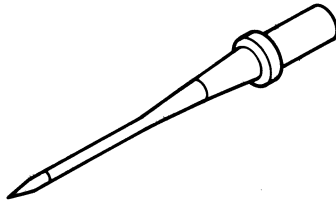

- (1 EACH) 6428897 PROBE, YELLOW, 8/32 IN.  
FOR USE WITH  
TRIPLETT METER
- (1 EACH) 1749249 PROBE, HIGH  
VOLTAGE RED,  
6/32 IN.
- (1 EACH) 1749250 PROBE, HIGH  
VOLTAGE BLACK,  
6/32 IN.

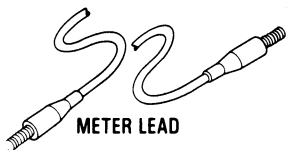

**METER LEAD**

1749252 LEAD, METER-RED  
1749253 LEAD, METER-BLACK  
8549388 REPAIR STUDS-BLACK  
8549389 REPAIR STUDS-RED

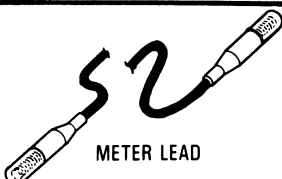

**METER LEAD**

1762920 TEST LEAD-RED  
1762921 TEST LEAD-BLACK  
FOR USE WITH 8022  
FLUKE METER

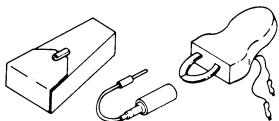

453554 AMPROBE, MODEL  
RS-3  
453555 PLUG OHMMETER



9900638 LEADS, PROBES &  
ALLIGATOR CLIPS  
FOR FLUKE 8020A  
MULTIMETER



453606 CONNECTOR-CONNECTS  
TWO LEADS, 6-32

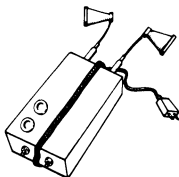

817971 PROBE, 100 NS  
INDICATOR SLD-MTS  
SYS/3

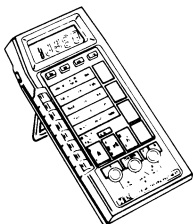

8496278 DIGITAL MULTI-  
METER 8060A/AA  
9900655 FUSE 2 AMP

FE USE ONLY

INCLUDES METER LEADS  
AND CASE

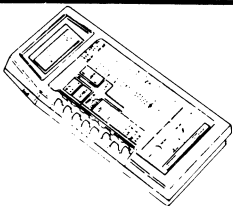

**9900628 DIGITAL MULTI-METER 8020 B/AF WITH dB CONVERSION DECAL METER LEADS AND CASE INCLUDED CSD USE ONLY**

**9900655 FUSE, 2 AMP**

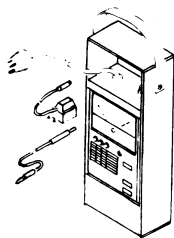

**1650792 ECOS ELECTRICAL SAFETY ANALYZER MODEL 1020 FE USE ONLY**

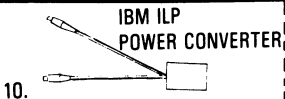

**10.**

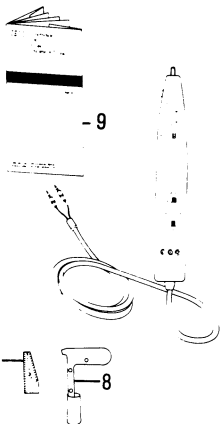
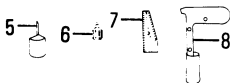
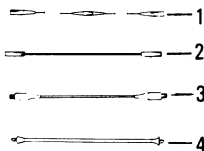

**453222 INTEGRATED LOGIC PROBE (WITH ACCESSORIES)**

- |     |   |     |
|-----|---|-----|
| 1.  | 2588263 GATE JUMPER 12 IN.              | (1) |
| 2.  | 8550208 GATE 10K RESISTOR JUMPER 12 IN. | (1) |
| 3.  | 8565942 GROUND LEAD 12 IN.              | (1) |
| 4.  | 5500900 GROUND LEAD 5 IN.               | (1) |
| 5.  | 8550205 STRAIGHT PROBE TIP PIN          | (1) |
| 6.  | 453167 SCT PROBE TIP STRAIGHT           | (3) |
| 7.  | 461159 ALLIGATOR CLIP                   | (3) |
| 8.  | 453826 SCT PROBE TIP FLAG               | (1) |
| 9.  | 5226-3951 IPC OPERATORS GUIDE           | (1) |
| 10. | 6428235 POWER MODULE                    |     |

**ORDER SEPARATELY**

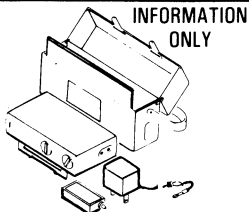

1749232 METER DATA  
PRECISION 258

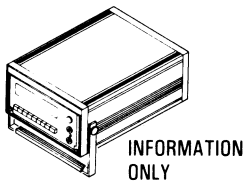

1749233 MULTIMETER,  
DIGITAL, DIGITEC  
2210, 100-200V

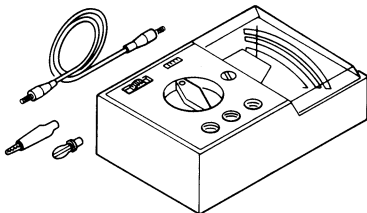

NO LONGER AVAILABLE

1749231 CE METER INFORMATION ONLY

453697 TEST LEAD SET  
CONSISTING OF

1749247 PLUG, BANANA-RED

1749248 PLUG, BANANA-BLACK

1749251 ALLIGATOR CLIP WITH  
BOOT-RED

1749255 ALLIGATOR CLIP WITH  
BOOT-BLACK

1749252 METER LEAD-RED

1749253 METER LEAD-BLACK

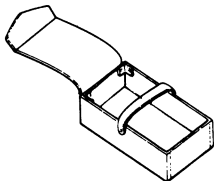

453514 CE METER CASE  
FOR 1749231

INFORMATION ONLY  
NO LONGER AVAILABLE

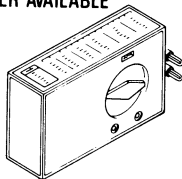

1749299 DB ADAPTER  
1647116 PLUG

	QNTY
9900529 EMC TEST CARD	(1)
1453794 MC II ALIGNMENT CARD	(1)
1496500 CE DIAGNOSTIC CARDS	(8)
1475938 OS/6 ALIGNMENT CARD	(1)
1496625 OS/6 DIAGNOSTIC DISK	(1)
1483784 6240 DIAGNOSTIC CARD	(1)
1492130 COMMUNICATING DIAGNOSTIC CARDS (SET OF 24 CARDS)	(1)
1463469 MC II AND 6240 COMMUNICATING DIAGNOSTIC CARDS (SET OF 3 CARDS)	(1)

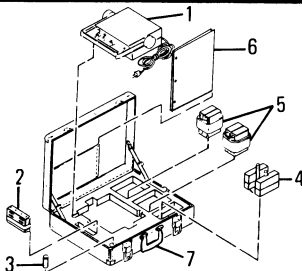

1. 1641153 IPAT ASSEMBLY 110V	(1)
1. 1641154 IPAT ASSEMBLY 220V	(1)
2. 1641158 IPAT JUMPER BLOCK	(1)
3. 9900047 BOTTLE	(1)
3. 5362303 PIN	(25)
4. 2282675 TERMINATOR, BUS	(1)
4. 5440650 TERMINATOR, TAG	(1)
5. 1857018 CABLE, EXTENDER IBM SYSTEM 370 INTERFACE	(1)
6. 5226-3958 MANUAL	(1)
7. 1641140 CASE ASSEMBLY	(1)



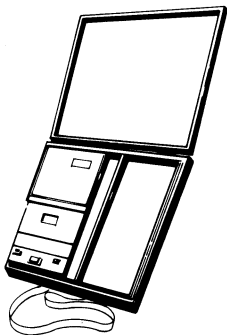

INFORMATION ONLY  
REPAIR AT ICAR

5500746 CASSETTE  
RECORDER  
NO LONGER  
AVAILABLE

5500749 CARRYING CASE

5500748 LABEL - USE  
ALCOHOL ONLY

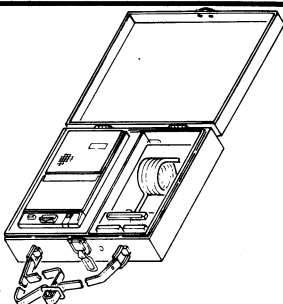

**CASSETTE RECORDER KIT  
ORDER INDIVIDUAL PART  
NUMBERS**

6339663 CASSETTE  
RECORDER

6339709 ADAPTER CABLE

1641279 CABLE ASM

1644326 FOAM

1865015 INDICATOR CARD

1811804 CARD GUIDE

8523376 ADAPTER CARD

5500749 CARRYING CASE



INFO  
ONLY  
REPAIR  
AT ICAR

453610 DYNAMIC TIMER  
ASSEMBLY

5442707 TRANSFORMER

5442710 SCREW, NYLON

5442712 FUSE

5442715 JACK

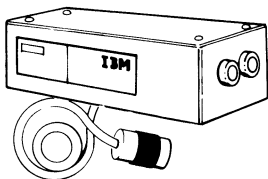

453646 LINE SCOPING  
TRANSFORMER

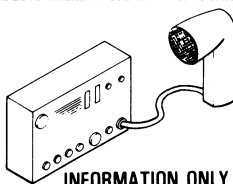

INFORMATION ONLY

453600 STROBOSCOPE, IBM

**GROUP 17**

**TESTERS AND TEST EQUIPMENT  
CE CABLES PLUGS AND TAPES**

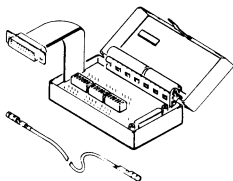

**453637 TEST SET, MODEM  
INTERFACE**  
**1864873 CORD, PATCH-  
DOUBLE SOCKET**

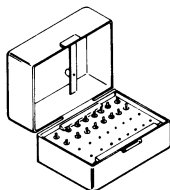

**2570250 TESTER ASM, CE  
3270**

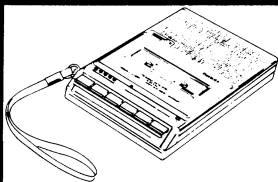

**6339663 MAGNAVOX®  
RECORDER**  
**6339684 110 VAC ADAPTER**  
**5133781 CABLE ADAPTER  
FOR 3614, 3624**  
**6339709 CABLE ADAPTER  
FOR S/7, 3770,  
3650 AND  
CASSETTE  
RECORDER KIT  
APPLICATIONS**

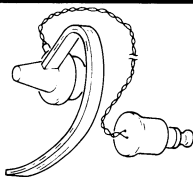

**2728116 EARPHONE**

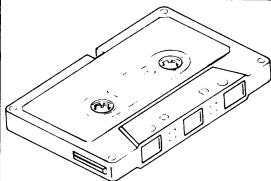

**1762848 CASSETTE - 300 FT**  
**1762853 CASSETTE - 1000 FT**

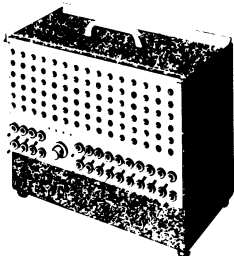

- 452400 TESTER, I-O
- 634499 TESTER OVERLAY 1442 N 1
- 647228 TESTER OVERLAY 2501
- 647521 TESTER OVERLAY 2501B
- 647625 TESTER OVERLAY 2520B
- 820324 TESTER OVERLAY 1443 N 1
- 827047 TESTER OVERLAY 2821 - 1403 - 2540
- 837890 TESTER OVERLAY 2540 - 1403  
WITH UNIV. CHAR. SET
- 838163 TESTER OVERLAY UCS DATA ENTRY SW.
- 838173 TESTER OVERLAY 1404 - 2540
- 2193977 TESTER OVERLAY 2841
- 2250852 TESTER OVERLAY 2314 - 2844
- 2984249 TESTER OVERLAY 2826
- 5159315 TESTER OVERLAY 2701 - SDA II
- 5724376 TESTER OVERLAY 2250 II
- 5740508 TESTER OVERLAY 2701 - TA II
- 8029740 TESTER OVERLAY 2671 - 2822
- 634429 TESTER OVERLAY 360 I/O 1442
- 5740551 TESTER OVERLAY 360 I/O, 2701/TTY II

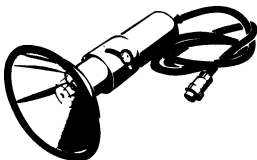

\*4261074 STROBE ASM

\*4261075 XENON FLASH BULB FOR 4261074

\*4261091 CARRYING CASE FOR 4261074

\*4261094 SAFETY SPECTACLES 65% DARK

**GROUP 17**

**TESTERS AND TEST EQUIPMENT,  
CE CABLES, PLUGS AND TAPES**

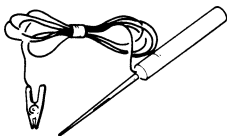

**802000 48 V TEST LAMP**

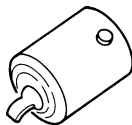

**316455 LAMP,  
REPLACEMENT FOR  
P/N 802000**

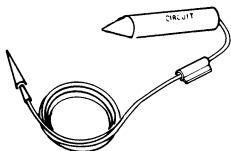

**9900516 CIRCUIT TESTER  
WITHOUT  
BATTERIES**

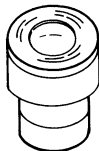

**9900463 OPTICAL  
COMPARATOR**

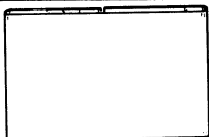

**9900159 BELT, IPE ABRASIVE  
9900176 BELT, 210 SERIES  
TEST  
9900503 BELT, 270, 170,  
224 IPE TEST**

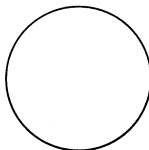

**1467853 DISC, ABRASIVE 6:5  
SERIES  
1467855 DISC, TEST 6:5  
SERIES**



**1644320 PLUG, EIA-CITT  
CABLE WRAP**

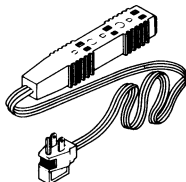

**1650755 EXTENSION CORD  
25 FT, EXT, 3-WIRE**

**NOTES:**

(

(

(

(

(

(

CONTAINERS, CASES, BOXES,  
CANS AND CARD CADDIES GROUP 18

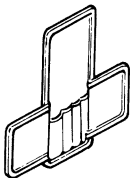

450467 POUCH CANVAS,  
SOCKET KEYS

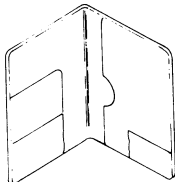

453594 FOLDER, WALLET  
TYPE

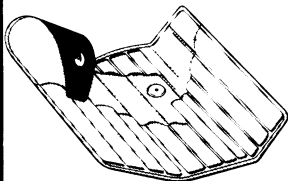

\*4261089 PLASTIC CASE,  
DRILL SET

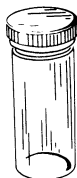

TUBE AND CAP, PLASTIC

450638 3/4 X 2 IN.

450637 7/8 X 2-1/2 IN.

9900047 VIAL, PLASTIC  
INCLUDES 2  
CAPS



9900323 CAP, BOTTLE (USE ON  
9900327 AND  
9900049)

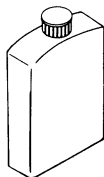

9900049 BOTTLE AND CAP  
WITHOUT LABEL  
9900327 BOTTLE AND CAP,  
WITH LABEL - FOR  
USE WITH CLEANING  
FLUID

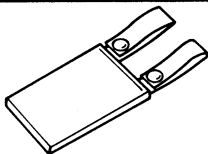

9900507 HOLSTER,  
RADIO

**GROUP 18**

**CONTAINERS, CASES, BOXES,  
CANS AND CARD CADDIES**

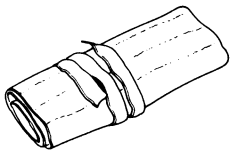

**9900073 TYPE BAR ROLL**

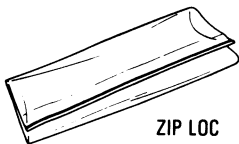

**ZIP LOC**

**9900387 ACCESSORY BAG,  
SMALL  
7395196 ACCESSORY BAG,  
LARGE**

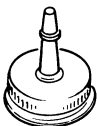

**9900052 CAP, USED WITH PT.  
& 1/2 PT. CANS**



**9900178 SPOUT, USED WITH  
GAL. CLEANING  
FLUID CAN**

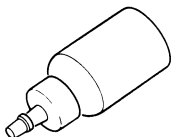

**1280057 CONTAINER 1 OZ.**

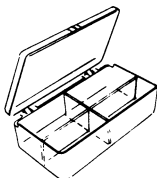

**454352 BOX, PLASTIC, 4  
SECT, 5 X 3 X 1 IN.**

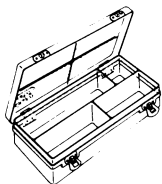

**\*4261088 BOX, PLASTIC,  
9 X 4 X 1 IN.**



**9900051 BOX, PLASTIC,  
1-3/4 X 1-3/4 X 5/8 IN.**

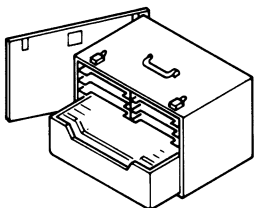

9900660 AUTO TRUNK PARTS  
CHEST

ORDER SEPARATELY:

450465 4-1/4" X 9-1/4 X  
1-1/2" NYLON  
PARTS BOX

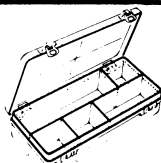

450465 BOX, NYLON 5 SECT,  
9-1/4 X 4-1/4 X 1-1/2  
9900687 BOX, NYLON  
NO PARTITIONS

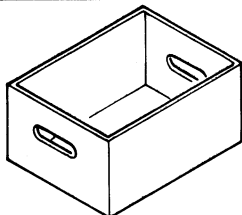

1852046 BOX PLASTIC  
15 1/2 X 7 1/4 X 5 IN.

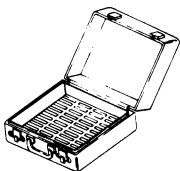

453561 CARD CADDY  
STORAGE CASE  
453562 CONTAINER, CARD  
10 2W, 2H CARDS

NOTE: 453561 WILL HOLD 6 OF  
453562

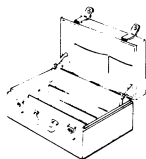

1857007 8100 SYSTEM  
CARD CADDY

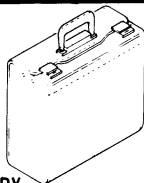

6428879 CARD CADDY  
INSIDE DIM 16 3/4 X 7 3/4 X 12 3/4 IN.

NOTE: FOR MISC USE P/N 1852046 PLASTIC BOX MAY BE PLACED  
INSIDE TO HOLD PARTS, CARDS, ETC.



**GROUP 18**

**CONTAINERS, CASES, BOXES,  
CANS AND CARD CADDIES**

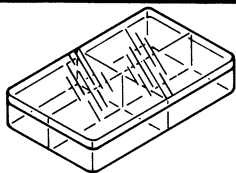

**9900593 BOX, PLASTIC, 4 SECT,  
4-5/8 X 3 X 1-1/8 IN.**

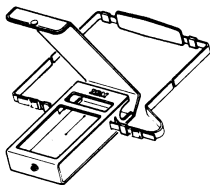

**9900747 CASE PDT  
CSD ONLY**

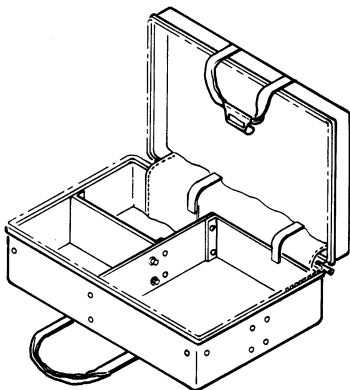

**6428141 CONDUCTIVE SOFT SIDED PARTS CADDY**

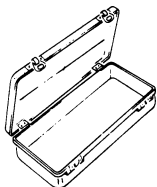

**6428275 ESD BOX CONDUCTIVE**

**FIELD SUPPLIES (LUBRICANTS, ADHESIVES, ETC.)**

◇ **WARNING: DO NOT STORE AEROSOL CONTAINERS IN AREAS WHERE THE TEMPERATURE MAY EXCEED 120°F, 48 °C (i.e. CLOSED AUTOMOBILE)**

261096 ADHESIVE, RUBBER CEMENT, 3M-826 (CLEAR)  
104774 ADHESIVE, RUBBER CEMENT, 3M-EC 847  
603910 ADHESIVE, RUBBER CEMENT, 3M-EC 2262  
4793775 ADHESIVE, GLYPTAL, INSULATING, 20Z BOTTLE  
450450 ADHESIVE, PERMATEX SEALANT  
1650774 ADHESIVE, EPOXY KIT  
605960 ADHESIVE, LOCTITE SEALANT, TYPE E  
615960 ADHESIVE, LOCTITE, PRIMER SEALANT  
1650948 ADHESIVE, INSTANT BONDING  
2175928 ADHESIVE, LOCITE SEALANT, TYPE H  
5715009 APRON, SYNTHETIC RUBBER

453638 BAG, PLASTIC - 3 IN. X 4 IN.  
453639 BAG, PLASTIC - 4 IN. X 6 IN.  
453640 BAG, PLASTIC - 12 IN. X 18 IN.  
453641 BAG, PLASTIC - 8-1/2 IN. X 17 IN.  
453642 BAG, PLASTIC - 6 IN. X 9 IN.  
453643 BAG, PLASTIC - 4 IN. X 6 IN.  
1748252 BATTERY (2 REQUIRED) PAGE COM  
1749281 BATTERY CAP, PAGE BOY  
453572 BATTERY, PAGE BOY  
453559 BINDER, 6 RING BLUE  
5246316 BLOCK, CLEANING

5442867 CAP, SAFETY W/LINER  
5715008 CAPE, RAWHIDE  
1268575 CLOTH, DROP  
1280055 CLOTH, DROP (3 PER PKG)  
1650800 CE RAGS, (50 PER BOX)  
9900632 CLEANER, GENERAL PURPOSE  
2648326 COMPRESSED AIR

◇ **8549396 DEGREASER, AEROSOL CAN**  
453522 DEVELOPING SOLUTION, 1/2 PT FOR 453505  
4136379 DISPOSABLE LAB COAT L  
4136358 DISPOSABLE LAB COAT XL  
  
1354922 1 OZ PACKET POWDERED HAND CLEANER

**FIELD SUPPLIES**  
**GROUP 19 (LUBRICANTS, ADHESIVES, ETC.)**

**FIELD SUPPLIES (CONTINUED)**

9900590 DISPOSABLE SHOP COAT M  
9900591 DISPOSABLE SHOP COAT L  
9900640 DISPOSABLE SHOP SHIRT M  
9900641 DISPOSABLE SHOP SHIRT L  
9900642 DISPOSABLE SHOP PANTS M  
9900643 DISPOSABLE SHOP PANTS L

1851995 EARPLUGS

5392438 FLUX, 2 OZ - BROWN  
◇ 2200032 FREON, PCA, CLEANING AGENT  
◇ 8549397 FREEZE MIST BIASING AGENT

9900644 GLOVES RUBBER - 12 PR. PER BOX  
5715011 GLOVES LINEMAN'S SIZE 11  
2200041 GLOVES, PLASTIC  
461621 GLOVES, NYLON, LINT-FREE  
337539 GREASE - SILICONE  
483151 GREASE - SILICONE, HEAT TRANSFER  
265390 GREASE - SILICONE, TUBE

5715010 HEADGEAR, WITH WINDOW - 18-1/4 X 10 X .06  
HOLDER, FORM NO. 299-0036

5392435 HUMISEAL, 2 OZ - BROWN  
2115252 HYDRAULIC OIL, GAL  
2164584 HYDRAULIC OIL, QT

9900690 KNEE PAD, 12 IN. X 17 IN. X 1 IN.

450109 LABEL, JAR

◇ 450936 LACQUER, BLUE GRAY, 715, TOUCHUP,  
12 OZ SPRAY

4136933 LACQUER, CHARCOAL BROWN, 734

◇ 8324623 LACQUER, CLASSIC BLUE, 747, 12 OZ SPRAY

◇ 2108181 LACQUER, DARK GRAY, 804, ACRYLIC,  
TOUCHUP, 6 OZ SPRAY

2108721 LACQUER, DEEP CHARCOAL, 717

◇ 5502806 LACQUER, FLAME RED, 716, TOUCHUP, 12 OZ  
SPRAY

◇ 8324624 LACQUER, GARNET ROSE, 749, 12 OZ SPRAY

**FIELD SUPPLIES**  
**(LUBRICANTS, ADHESIVES, ETC.) GROUP 19**

**FIELD SUPPLIES (CONTINUED)**

- ◇ 2108180 LACQUER, LIGHT GRAY, COARSE, 713 TOUCHUP,  
6 OZ SPRAY
- 2744699 LACQUER, OFF WHITE, 718
- ◇ 634779 LACQUER, PEARL WHITE, 719, TOUCHUP,  
12 OZ SPRAY
- 7367477 LACQUER, PEARL WHITE, SMOOTH, 728
- 1608809 LACQUER, PEBBLE GRAY, 733
- ◇ 2108184 LACQUER, RAVEN BLACK, 714, 6 OZ SPRAY
- ◇ 603717 LACQUER, RAVEN BLACK, SMOOTH, 724, 12 OZ  
SPRAY
- ◇ 5502807 LACQUER, SKY BLUE, 720, TOUCHUP, 12 OZ SPRAY
- 4136932 LACQUER, SLATE GRAY, 736
- ◇ 2108723 LACQUER, SUNRISE YELLOW, 730, TOUCHUP,  
12 OZ SPRAY
- 4136934 LACQUER, SUNRISE YELLOW, 735
- ◇ 8324621 LACQUER, WILLOW GREEN, 748, 12 OZ SPRAY
- 2200118 LIQUID, ANTI-STATIC 2314
- 5442868 LINER, REPLACEMENT FOR 5442867  
(SEE CAP, SAFETY W/LINER)
- 1236595 LUBRICANT, NO. 2 1/4 OZ CLOCK OIL 401-D
- 477567 LUBRICANT, NO. 3 HYDRAULIC OIL, GAL
- 450669 LUBRICANT, NO. 4, PT
- 450670 LUBRICANT, NO. 4 QT
- 223980 LUBRICANT, NO. 6 PT
- 450315 LUBRICANT, NO. 6, GAL
- ◇ 451110 LUBRICANT, NO. 6, SPRAY, 6 OZ CAN
- 2127714 LUBRICANT, NO. 7, COMPRESSOR OIL, PT
- 450668 LUBRICANT, NO. 9 PT
- 450676 LUBRICANT, NO. 9 QT
- 450133 LUBRICANT, NO. 12, QT
- \*771627 LUBRICANT, NO. 12, ONE LITER CAN
- 450052 LUBRICANT, NO. 15, QT
- 450238 LUBRICANT, NO. 15, PT
- 450556 LUBRICANT, NO. 17, LB
- \*771821 LUBRICANT, NO. 17, 200 GRAM TUBE
- 117397 LUBRICANT, NO. 20, LB
- \*771674 LUBRICANT, NO. 20, 100 GRAM TUBE
- 260781 LUBRICANT, NO. 22, LB
- \*771625 LUBRICANT, NO. 22, 100 GRAM TUBE
- 1280441 LUBRICANT, NO. 23, 1/2 OZ TUBE
- 9900692 LUBRICANT, NO. 23, 8 OZ TUBE
- 1280442 LUBRICANT, NO. 23, 1 LB CAN

**FIELD SUPPLIES**

**GROUP 19 (LUBRICANTS, ADHESIVES, ETC.)**

**FIELD SUPPLIES (CONTINUED)**

- 450633 LUBRICANT, NO. 24, LB
- 451053 LUBRICANT, CARD CONTACT, 4 OZ CAN
- 471519 LUBRICANT, DRUM BEARING, 1 LB .45 KILO
- 2133355 LUBRICANT, LB 300 X OIL, PT
- 453682 LUBRICANT, LUBRIPLATE NO. 70, PT
- 453391 LUBRICANT, PIN
  
- 9900418 MAGNETIC TAPE DEVELOPER
- \*352407 MARKER, MAGNETIC TAPE
- 357830 MOLYCOTE TYPE G
- \*771494 MOLYCOTE 350B, 10 GRAM TUBE
- \*771847 MOLYCOTE BR2, 100 GRAM CAN
- 1280018 MOLYCOTE, TUBE, TYPE G-N PASTE
- 5144304 MOLYCOTE G RAPID, 2 OZ
- \*8026752 MOLYCOTE, 1 LB
  
- 1797703 OIL CARTRIDGE LUBRICANT
- 2115444 OIL-CLOCK MOTOR, 1 OZ, 28,3 GRAMS
- 1280443 OIL IBM 10, 4 OZ BOTTLE
- 1280444 OIL IBM 10, 1 PT CAN
- 9900177 PLASTIC POLISH
- 641458 PAINT, SILVER CONDUCTIVE
- 8496274 PAPER SLEEVES
- ◇ 450936 **PLASTIC SPRAY, 12 OZ**
- \*771754 PLEXIKLAR, CLEANING FLUID ANTISTATIC,  
100 GRAM B
  
- 1650800 RAGS
- 461305 RIBBON, CLEANING 557
  
- 216348 SEALANT, LOCITE TYPE A, 2 CC TUBE
- 889524 SEALANT, SILICONE-RUBBER ADHESIVE 5280
- 450405 SKIN CREME, MONO DERMIN, 50 GRAM TUBE
- 1650976 SMOCK, EXTRA SMALL
- 289273 SMOCK, SMALL
- 289274 SMOCK, MEDIUM
- 289275 SMOCK, LARGE
- 1650977 SMOCK, EXTRA LARGE
- 2106774 SOLVENT, LETTERING
- 450608 SOLVENT, IBM CLEANING, 6 OZ CAN
- 1280017 SOLVENT, IBM CLEANING FLUID, 1 GAL

**FIELD SUPPLIES (CONTINUED)**

450891	SOLVENT, CLEANER, COVER, 8 OZ CAN	
2200200	SOLVENT 91% ISOPROPYL ALCOHOL, 6 OZ BOTTLE	
2286522	SOLVENT, CLEANER	
641462	SOLDER PASTE 50-50	
353887	SOLDER, ROSIN CORE	7302
2155966	SOLVENT, 91% ALCOHOL ISOPROPYL, (5) 6 OZ BOTTLES	
9900050	SPONGE, CLEANING	
9900679	SOLVENT ALCOHOL PAD	
2200043	TAPE, GREEN, STRIP HOUSING 2321	
9900502	TAPE, FILAMENT PACKING	
1782542	TAPE PHYSICAL HAZARD 2 IN. X 54 FT	
450692	TAPE, PLASTIC ELECT, 1/2 IN. X 36 YDS., BLK	
450695	TAPE, FRICTION, 3/4 IN. X 45 FT	
451545	TAPE, FILAMENT, 1/2 IN. 36 YD ROLL	
450695	TAPE, FRICTION, 3/4 IN. X 1/2 LB	
241863	TAPE, PRESSURE SENSITIVE, PRINTABLE, 3/8 IN.	
451546	TAPE, MASKING, PAPER, 1 IN.	
596763	THREAD SEALANT	
450701	WAX EMULSION	

**CONVERSION TABLE**

1 OZ (ounce)	-	28.3 Grams
1 LB (pound)	-	.45 Kilogram
1 PT (pint)	-	.5 Liter
1 QT (quart)	-	.9 Liter
1 GAL (gallon)	-	3.8 Liters
1 IN. (inch)	-	25.4 MM

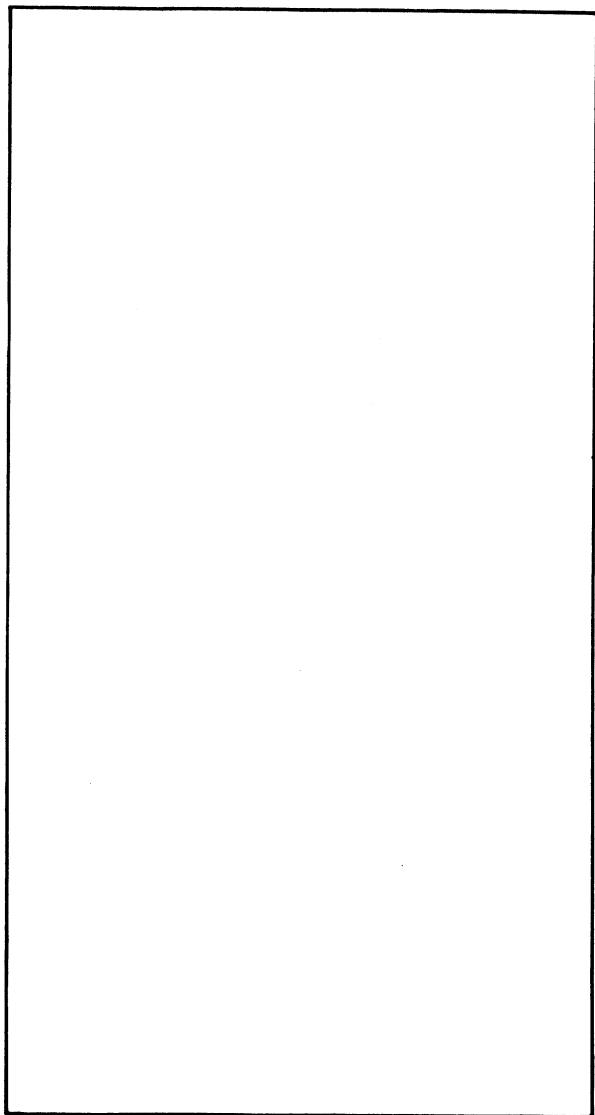

## ALPHABETICAL INDEX

GROUP 20

DESCRIPTION	GP-PG	PT NO.
ABRASIVE FLEXTONE	1-5	0165866
ABRASIVE LINEN,CROCUS CLOTH	5-53	1650887
ABRASIVE PAPER,150A,COARSE	5-53	0158955
ABRASIVE PAPER,600A,FINE	5-53	9900089
ACCESSORY BAG	1-5	9900387
ACCESSORY BAG,LARGE	18-132	7395196
ACCESSORY BAG,SMALL	18-132	9900387
ACTIVE PROBE-MST 2-4 CARD	14-99	2728231
ADAPTER CABLE,CASSETTE REC	17-126	6339709
ADAPTER CARD,CASSETTE REC	17-126	8523376
ADAPTER,3/8" TO 1/4"	8-73	2108746
ADAPTER,6/32	15-111	5500901
ADAPTER,6/32"-BLACK (QTY 2)	16-120	7838692
ADAPTER,6/32"-RED (QTY 2)	16-120	7838691
ADAPTER,BNC TO BINDER POST	15-110	0453184
	15-114	0453184
ADAPTER,CABLE 3614,3624 REC	17-127	5133781
ADAPTER,CABLE S/7,3770,3650	17-127	6339709
ADAPTER,CASSETTE REC,110V	17-127	6339684
ADAPTER,COAX BNC TO UHF	15-109	0450837
ADAPTER,COAX BNC TO UNF	15-110	0450837
ADAPTER,HEX WRENCH 3/16	2-25	0451913
ADAPTER,MINI/SUBMINI PROBE	15-111-	7838680
ADAPTER,P 6010 TO 6-32 THD	15-114	0453164
	15-115	0453164
ADAPTER,PROBE TIP TO BNC	15-110	0453199
ADAPTER,SCOPE ACC/TEST LEAD	15-110	1310714
ADAPTER,SIMPSON METER-BLACK	16-120	6428111
ADAPTER,SIMPSON METER-RED	16-120	6428110
ADHESIVE,EPOXY KIT	19-135	1650774
ADHESIVE,GLYPTAL,2 OZ	19-135	4793775
ADHESIVE,INSTANT BONDING	19-132	1650948
ADHESIVE,LOCTITE, TYPE H	19-135	2175928
ADHESIVE,LOCTITE,PRIMER SEAL	19-135	0615960
ADHESIVE,LOCTITE,TYPE E	19-135	0605960
ADHESIVE,PERMATEX SEALANT	19-135	0450450
ADHESIVE,RUBBER,3M-826	19-135	0261096
ADHESIVE,RUBBER,3M-EC 2262	19-135	0603910
ADHESIVE,RUBBER,3M-EC 847	19-135	0104774
ADJUSTING TOOL,MINI-POT	3-41	1864853
ADJUSTING TOOL,SPRING	7-87	0489150



GROUP 20      ALPHABETICAL INDEX

DESCRIPTION	GP-PG	PT NO.
ALIGNER,GROUND RAIL,MST-2-4	14-102	0453777
ALIGNER,PIN	14-102	0453473
ALIGNER,PIN-SINGLE	14-102	0453857
ALIGNING TOOL,CODE PLATE	7-66	0460028
ALIGNING WRENCH	1-5	9900093
ALIGNING WRENCH,TYPE	7-68	9900093
ALIGNMENT TOOL,COMBINED	7-68	9900589
ALIGNMENT TOOL,HEAD	7-68	2200698
ALLIGATOR CLIP,GEN LOGIC	16-118	0461159
ALLIGATOR CLIP,LOGIC PROBE	16-123	0461159
ALLIGATOR CLIP-BLACK	16-120	7838688
ALLIGATOR CLIP-RED	16-120	7838687
ALLIGATOR CLIPS	16-120	9900729
AMPROBE,MODEL RS-3	16-122	0453554
ANALYZER,DRANETZ 626	16-119	8496301
ANALYZER,ECOS-CSD ONLY	16-119	8549350
ANALYZER,ECOS-MODEL 1020	16-123	1650792
APPLICATOR E-RING 2314	6-61	2200103
APRON,SYNTHETIC RUBBER	19-135	5715009
ARMATURE,POWER CLEANER	10-83	9900544
BAG,PLASTIC,PROBE ACC	15-114	0453183
BAG,PLASTIC-12 IN. X 18 IN.	19-135	0453640
BAG,PLASTIC-3 IN. X 4 IN.	19-135	0453638
BAG,PLASTIC-4 IN. X 6 IN.	19-135	0453639
		0453643
BAG,PLASTIC-6 IN. X 9 IN.	19-135	0453642
BAG,PLASTIC-8-1/2" X 17"	19-135	0453641
BASE LINE TOOLS	1-19	9900008
BATTERY	16-121	9900587
BATTERY CAP,PAGE BOY	19-135	1749281
BATTERY,PAGE BOY	19-135	0453572
BATTERY,PAGE COMMUNICATOR	19-135	1748252
BEARING KIT,INSUL SEL I/O	7-65	9900523
BEARING,POWER CLEANER	10-83	9900546
		9900547
		9900542
BEARING,SUPPORT	10-83	9900569
BELT,210 SERIES TEST	17-129	9900176
BELT,270,170,224 IPE TEST	17-129	9900503
BELT,IPE ABRASIVE	17-129	9900159
BENDING TOOL,BRUSH	7-67	0450364

## ALPHABETICAL INDEX

GROUP 20

DESCRIPTION	GP-PG	PT NO.
BENDING TOOL,CENTER,SEL I/O	7-65	9900253
BENDING TOOL,CHUTE BLADE END	7-67	0010407
BENDING TOOL,CONT,SELECTOR	7-67	0450224
BINDER,6 RING BLUE	19-135	0453559
BINDER,6 RING-FE HANDBOOKS	9-77	0453559
BLADE,BURNISHING AG CONTACT	5-51	0450567
BLADE,BURNISHING TOOL	5-52	9900359
BLADE,HAND HACKSAW 24 T,10"	5-53	0450156
BLADE,HAND HACKSAW,32 T,10"	5-53	0450157
BLADE,HAND HACKSAW,32 T,6"	5-53	0450433
BLADES,GRAM SCALE- X1	8-71	0451914
BLADES,GRAM SCALE- X10	8-71	0451915
BLADES,GRAM SCALE- X2	8-71	0451916
BLADES,GRAM SCALE- X20	8-71	0451049
BLADES,GRAM SCALE- X5	8-71	9900265
BLOCK,CLEANING	19-135	5246316
BODY AND SLEEVE ASM	15-111	5495151
BOTTLE AND CAP W/O LABEL	18-131	9900049
BOTTLE AND CAP,W/LABEL	18-131	9900327
BOTTLE,IPAT ASM	17-125	9900047
BOX,CLEANER [TAPE CLEANER]	10-85	0352466
BOX,CONDUCTIVE	14-99	6428275
BOX,ESD-CONDUCTIVE	18-134	6428275
BOX,NYLON NO PARTITIONS	18-133	9900687
BOX,NYLON,5 SECTION	18-133	0450465 0450465
BOX,PLASTIC	8-73	2108312
BOX,PLASTIC SOCKET SET	2-23	0451148
BOX,PLASTIC,4 SECT	18-132	9261088
	18-134	9900593
BOX,PLASTIC,4 SECT (SMALL)	18-132	9900051
BOX,PLASTIC,4 SECT,5" X 3"	18-132	0454352
BOX,PLASTIC-15-1/2" X 7-1/4"	18-133	1852046
BRASS ROD- 3/4" HEX X 20"	6-58	0450546
BRASS ROD- 5/16" HEX X 6"	6-58	0004047
BRUSH,(TAPE CLEANER)	10-85	0453536
BRUSH,CLEANER,2 1/2" NYLON	10-85	0556945
BRUSH,CLEANING-PHOTOCELL	10-81	0451555
BRUSH,OIL	10-81	9900014
BRUSH,RED HANDLE	10-81	0003701
BRUSH,SASH,TOOL BAG	10-81	0450732

## GROUP 20

## ALPHABETICAL INDEX

DESCRIPTION	GP-PG	PT NO.
BRUSH,SOFT	10-81	9900719
BRUSH,TAPE PATH CLEANING	10-85	2513590
BRUSH,TYPE CLEANING	1-5	0453536
	10-81	0453536
BULB NON SHROUDED OUTLETS	9-77	2728186
BULB,110V,25W	9-77	4116511
BULB,220V,25W	9-77	4116650
BULB,MAGNIFIER	9-79	0453404
BURNISHING TOOL	5-52	9900360
BUSHING,DRIVE,CE TOOL	6-58	2494907
CABLE ASM CASSETTE RECORDER	17-126	1641279
CABLE EXTENDER,SYSTEM 370	17-125	1857018
CABLE,GLP EXTENDER	16-118	0453605
CABLE,POWER-MST 2-4 CARD	14-99	2728246
CAM FOLLOWER REMOVAL TOOL	1-22	9900709
CAP,BOTTLE,9900327/9900049	18-131	9900323
CAP,PROTECTOR,453161	15-114	0453180
CAP,PROTECTOR,453161/453162	15-115	0453180
CAP,PT. & 1/2 PT. CANS	18-132	9900052
CAP,SAFETY W/LINER	19-135	5442867
CAPACITOR,POWER CLEANER	10-83	9900556
CAPE,RAWHIDE	19-135	5715008
CARBON RIBBON,ADJ.	7-64	9900379
CARD ASM,LATCH MST 2-4	14-99	2728225
CARD ASM-MST 2-4 LATCH	14-99	2728228
CARD CADDY 16-3/4" X 12-3/4"	18-133	6428879
CARD CADDY STORAGE CASE	18-133	0453561
CARD CADDY,8100 SYSTEM	18-133	1857007
CARD EXTENDER,1 WIDE	14-105	2360390
CARD EXTENDER,4 WIDE	14-105	2360393
CARD GUIDE CASSETTE GUIDE	17-126	1811804
CARD SAW 129	10-81	0961343
CARD,6240 DIAGNOSTIC	17-125	1483784
CARD,ALIGNMENT-OS/6	17-125	1475938
CARD,ALIGNMENT-MC II	17-125	1453794
CARD,DIAGNOSTIC-MC II/6240	17-125	1463469
CARRYING CASE,CASSETTE REC	17-126	5500749
CARRYING CASE,STROBE ASM	17-128	4261091
CARRYING CASE,VACUUM CLEANER	10-81	1646827
CART BASKET,TOP-16 VOLM.	15-117	1753726
CART STRETCH CORD 24 IN.	16-118	5997461
CART STRETCH CORD 72 IN.	16-118	8549398

## ALPHABETICAL INDEX

GROUP 20

DESCRIPTION	GP-PG	PT NO.
CART TOP UNIT,11" BINDERS	15-117	0453148
CART,MANUAL & SCOPE 36 VOL.	15-117	0453147
CART,MIGHTY MINI	16-118	1762922
CART,MINI	15-117	0453644
CART,SCOPE TEKTRONIX 200C	15-117	8549395
CASE ASSEMBLY	17-125	1641140
CASE,CE METER 1749231	16-124	0453514
CASE,PDT	18-134	9900747
CASE,PLASTIC	3-41	0451134
CASE,PLASTIC-DRILL SET	18-131	4261089
CASE,PROGRAM SUPPORT	1-10	0453663
	1-16	0453663
CASE,TRIPLETT METER	16-121	9900586
CASE,ZIPPER	1-10	0451550
	1-16	0451550
CASSETTE RECORDER	17-126	5500746
		6339663
CASSETTE RECORDER,MAGNAVOX	17-127	6339663
CASSETTE,1000 FT	17-127	1762853
CASSETTE,300 FT	17-127	1762848
CASTER B/M,453644 CART	15-117	1749000
CASTER,453147 CART	15-117	0453154
CE DIAGNOSTIC CARDS	17-125	1496500
CE METER	1-7	8496278
	1-9	8496278
	16-124	1749231
CE METER ALLIGATOR CLIP-BLK	16-124	1749255
CE METER ALLIGATOR CLIP-RED	16-124	1749251
CE METER LEAD-BLACK	16-124	1749253
CE METER LEAD-RED	16-124	1749252
CE METER PLUG,BANANA-BLACK	16-124	1749248
CE METER PLUG,BANANA-RED	16-124	1749247
CE METER TEST LEAD SET	16-124	0453697
CE RAGS,50 PER BOX	19-135	1650800
CHART,REC THERMOMETER	8-74	1749260
CHECKER ASM,PHASE SEQUENCE	16-119	0453203
CHEST,PARTS-AUTO TRUNK	18-133	9900660
CIRCUIT TESTER W/O BATTERIES	17-129	9900516
CLEANER,CHUTE BLADE	10-81	0003339

## GROUP 20

## ALPHABETICAL INDEX

DESCRIPTION	GP-PG	PT NO.
CLEANER, GENERAL PURPOSE	19-135	9900632
CLEANING FLUID, ANTISTATIC	19-138	0771754
CLIP, ALLIGATOR, 6-32 BLACK	15-116	1749255
CLIP, ALLIGATOR, 6-32 RED	15-116	1749251
CLIP, ALLIGATOR, PROBE, 6-32	15-114	0461159
CLIP, ALLIGATOR, SMALL, 6-32	15-116	0461159
CLOTH, DROP	19-135	1268575
CLOTH, DROP, 3 PER PKG	19-135	1280055
CLOTH, LINTFREE 9" X 9"	10-85	2108930
CLOTH-COLORED, KG	10-84	4098027
CLOTH-COPIER DRUM	10-84	9900724
CLOTH-LINEN, KG	10-84	4691431
CLOTH-LINTFREE, BOX OF 50	10-84	1477753
CLOTH-LINTFREE, PACK OF 10	10-84	2108930
COAXIAL CABLE STRIPPER	4-47	5230082
COMMUNICATING DIAG CARDS	17-125	1492130
COMPRESSED AIR	19-135	2648326
CONNECTOR, BNC	15-109	1650766
CONNECTOR, PRESSURE, 80 IN.	8-73	2111942
CONNECTOR, TWO LEADS, 6-32	16-122	0453606
CONTACT BENDER	7-68	9900505
CONTAINER 1 OZ.	18-132	1280057
CONTAINER, 10 2W, 2H CARDS	18-133	0453562
CONTINUITY CHECKER	14-105	0453587
CONTINUITY CHECKER BULB	14-105	5353889
CONTINUITY CHECKER, 1.35V	14-105	0453119
CONTINUITY CHECKER, 2.80V	14-105	0453120
CONTROL CORD, ESD	14-99	6428166
CORD & SWITCH, POWER CLEANER	10-83	9900553
CORD, EXTENSION 25 FT, 3-WIRE	17-129	1650755
CORD, PATCH-DOUBLE SOCKET	17-127	1864873
CORD, POWER, 110V 8 FT, 453	15-114	0453194
CORD, POWER, 220V, 8 FT, 453	15-114	0453520
COUNTERSINK, 82 DEG, 1/4 SHANK	13-90	0454302
COUNTERWEIGHT, POWER CLEANER	10-83	9900543
COUPLING, BANANA PLUG, 6-32	15-116	4261080
COVER, CAPACITOR, PWR CLEANER	10-83	9900555
COVER, MOTOR, POWER, CLEANER	10-83	9900535
COVER, POWER CLEANER	10-83	9900554
COVERS, LENS	7-67	9900685
CRANK ASM, POWER CLEANER	10-83	9900568
CRIMPING TOOL BURNDYMR 8-1A	4-48	0460294
CRIMPING TOOL, AMP 29359-1	4-48	0450898

## ALPHABETICAL INDEX

GROUP 20

DESCRIPTION	GP-PG	PT NO.
CRIMPING TOOL,AMP 2948-4	4-48	0453575
CRIMPING TOOL,AMP 45639	4-48	0453510
CRIMPING TOOL,AMP 59501	4-48	0461070
CSD TOOL SET,LARGE-OLIVE	1-13	1643918
CSD TOOL SET,SMALL-BLUE	1-15	1643916
CSD TOOL SET,SMALL-BROWN	1-15	1643917
DB ADAPTER	16-124	1749299
DECAL,CLEANING INSTRUCTION	10-85	0352561
DEGREASER,AEROSOAL CAN	19-135	8549396
DELETE FERRULE DEEP MST-4	14-105	0453942
DELETE FERRULE DEEP MST-4 DEEP CUTTER	14-105	0453808
DELETE FERRULE, SLT MST-1 SHALLOW	14-105	0452572
DELETE FERRULE, ASLT MST-2-4-X	14-105	0453461
DELETE FERRULE, MST-2-4-X SHALLOW	14-105	0452572
DELETE FERRULE, DEEP MST-2 DOUBLE	14-105	0453780
DELETE FERRULE,DEEP ASLT MSTX	14-105	0461556
DELETE FERRULE,DEEP ASLT MSTX SET SCREW	14-105	0074530
DELETE FERRULE,DEEP ASLT MSTX RETAINING CLIP	14-105	0453061
DELETE FERRULE,DEEP ASLT MSTX RETAINING RING	14-105	0453944
DELETE FERRULE,DEEP ASLT MSTX DELETE CUT	14-105	0461545
DELETE FERRULE,DEEP MST-2 DOUBLE DELETE CUT	14-105	0453808

**GROUP 20      ALPHABETICAL INDEX**

<b>DESCRIPTION</b>	<b>GP-PG</b>	<b>PT NO.</b>
DELETE FERRULE,DEEP MST-2 DOUBLE RETAINING RING	14-105	0453944
DELETE FERRULE,DEEP MST-2 DOUBLE SET SCREW	14-105	0074530
DELETE FERRULE,DEEP MST-4 SET SCREW	14-105	0074530
DELETE FERRULE,DEEP MST-4 RETAINING RING	14-105	0453944
DELETE FERRULE,MST-2-4-X SET SCREW	14-105	0074530
DELETE FERRULE,MST-2-4-X RETAINING RING	14-105	0453944
DELETE FERRULE,SLT MST-1	14-105	0453059
DELETE FERRULE,SLT MST-1 SET SCREW	14-105	0074530
DELETE FERRULE,SLT MST-1 RETAINING CLIP	14-105	0453061
DELETE FERRULE,SLT MST-1 RETAINING RING	14-105	0453944
DELETE TOOL,7 IN. 178MM	14-101	0452626
DEVELOPING SOLUTION,1/2 PT	19-135	0453522
DIAL INDICATOR,POINT	8-72	0450948
DISC,ABRASIVE 6:5 SERIES	17-129	1467853
DISC,DIAGNOSTIC-OS/6	17-125	1496625
DISC,TEST 6:5 SERIES	17-129	1467855
DISPLAY CARD,12 POS STAGE 1	14-103	5803976
DISPLAY CARD,12 POS STAGE 2	14-103	5803975
DRILL SET,NO. 1 THRU 60	13-91	0450716
DRILL,1/4 IN.	13-92	0004003
DRILL,1/4" SHANK- 11/32"	13-95	0450055
DRILL,1/4" SHANK- 3/8"	13-95	0450371
DRILL,1/4" SHANK- 5/16"	13-95	9900077
DRILL,1/4" SHANK- Q	13-95	0450421

## ALPHABETICAL INDEX

GROUP 20

DESCRIPTION	GP-PG	PT NO.
DRILL, 1/4" SHANK-1/2"	13-95	0450369
DRILL, 1/8 IN.	13-92	0003993
DRILL, 110V 3/8 IN. CHUCK	13-90	1749264
DRILL, 15/64 IN.	13-92	0450169
DRILL, 17/64 IN.	13-92	0055773
DRILL, CARBIDE TIP, NO. 36	13-90	9900107
DRILL, D	13-92	0004002
DRILL, EXTENSION- 1/2 IN.	13-94	0154292
DRILL, EXTENSION- 1/4 IN.	13-94	0450152
DRILL, EXTENSION- 1/8 IN.	13-94	0450237
DRILL, EXTENSION- 7/32 IN.	13-94	0450048
DRILL, EXTENSION-NO. 14	13-94	0173262
DRILL, EXTENSION-NO. 16	13-94	0158799
DRILL, EXTENSION-NO. 19	13-94	0450047
DRILL, EXTENSION-NO. 20	13-93	0171308
	13-94	0171308
DRILL, EXTENSION-NO. 21	13-94	0154365
DRILL, EXTENSION-NO. 24	13-94	0173261
DRILL, EXTENSION-NO. 28	13-94	0450236
DRILL, EXTENSION-NO. 29	13-94	0173260
DRILL, EXTENSION-NO. 33	13-94	0450002
DRILL, EXTENSION-NO. 37	13-94	0450058
DRILL, EXTENSION-NO. 48	13-94	0167717
DRILL, EXTENSION-NO. 53	13-94	0450253
DRILL, EXTENSION-NO. 7	13-94	0178666
DRILL, F	13-92	0450170
DRILL, NO. 1	13-91	0055781
DRILL, NO. 10	13-91	0003999
DRILL, NO. 11	13-91	0450301
DRILL, NO. 12	13-91	0003998
DRILL, NO. 13	13-91	0003997
DRILL, NO. 14	13-91	0450278
DRILL, NO. 15	13-91	0055771
DRILL, NO. 16	13-91	0450166
DRILL, NO. 17	13-91	0450130
DRILL, NO. 18	13-91	0450165
DRILL, NO. 19	13-91	0003996
DRILL, NO. 2	13-91	0450300
DRILL, NO. 20	13-91	0055770
DRILL, NO. 21	13-91	0450164
DRILL, NO. 22	13-91	0450265
DRILL, NO. 23	13-91	0055769



## GROUP 20

## ALPHABETICAL INDEX

DESCRIPTION	GP-PG	PT NO.
DRILL,NO. 24	13-91	0450287
DRILL,NO. 25	13-91	0450289
DRILL,NO. 26	13-91	0003995
DRILL,NO. 27	13-91	0003994
DRILL,NO. 28	13-91	0055767
DRILL,NO. 29	13-91	0450163
DRILL,NO. 3	13-91	0450272
DRILL,NO. 30	13-91	0450290
DRILL,NO. 31	13-91	0003992
DRILL,NO. 32	13-91	0003991
DRILL,NO. 33	13-91	0055766
DRILL,NO. 34	13-92	0450302
DRILL,NO. 35	13-92	0003990
DRILL,NO. 36	13-92	0003989
DRILL,NO. 37	13-92	0450162
DRILL,NO. 38	13-92	0450179
DRILL,NO. 39	13-92	0450291
DRILL,NO. 4	13-91	0450298
DRILL,NO. 40	13-92	0055764
DRILL,NO. 41	13-92	0450263
DRILL,NO. 42	13-92	0450161
DRILL,NO. 43	13-92	0003988
DRILL,NO. 44	13-92	0055763
DRILL,NO. 45	13-92	0003987
DRILL,NO. 46	13-92	0450256
DRILL,NO. 47	13-92	0450160
DRILL,NO. 48	13-92	0055762
DRILL,NO. 49	13-92	0450159
DRILL,NO. 5	13-91	0004001
DRILL,NO. 50	13-92	0450257
DRILL,NO. 51	13-92	0003986
DRILL,NO. 52	13-92	0450279
DRILL,NO. 53	13-92	0450262
DRILL,NO. 54	13-92	0450258
DRILL,NO. 55	13-92	0450259
DRILL,NO. 56	13-92	0450037
DRILL,NO. 57	13-92	0450299
DRILL,NO. 58	13-92	0450303
DRILL,NO. 6	13-91	0450168
DRILL,NO. 60	13-92	0450264
DRILL,NO. 7	13-91	0450277
DRILL,NO. 8	13-91	0004000
DRILL,NO. 9	13-91	0450167

## ALPHABETICAL INDEX

GROUP 20

DESCRIPTION	GP-PG	PT NO.
DRIVE, 1/4 IN. SQ.	3-41	0451132
DRIVER, SPLINE, TIP 2301-2303	2-32	2200176
DRUM PULL TOOL 2321	6-61	2200205
DYNAMIC HALF CYCLE TOOL, SEL	2-29	9900375
DYNAMIC TIMER ASSEMBLY	17-126	0435610
EARPHONE	17-127	2728116
EARPLUGS	19-136	1851995
ECCENTRIC, POWER CLEANER	10-83	9900541
EMC TEST CARD	17-125	9900529
EMEA CE TOOL CASE	1-3	4057140
ESD KIT	1-11	6428316
	1-17	6428316
	1-4	6428316
	14-99	6428316
EXTENDER ASM, MST-4	14-108	0453454
EXTENDER ASM, OFFSET MST-4	14-108	5853341
EXTENDER, ASLT MSTX	14-108	0453740
EXTENDER, CARD & CABLE ASMS	14-98	0451075
EXTENDER, CARD, 36" CABLE	14-98	0452399
EXTRACT TOOL	14-100	1310707
EXTRACT TOOL, IC MODULE	6-58	9900764
EXTRACTION DEVICE MODULE	14-99	0453400
	4-49	0453400
EXTRACTOR, AMP 126056-1	6-57	0453509
EXTRACTOR, AMP 305141-1	6-59	0453506
EXTRACTOR, AMP 380305-2	6-57	2108493
EXTRACTOR, AMP 455822-2	6-59	9900718
EXTRACTOR, AMP 91017	6-57	0452815
EXTRACTOR, BULB	6-59	0461061
EXTRACTOR, BURNDY RX 12-6	6-59	0461046
EXTRACTOR, BURNDY RX 16-5	6-59	0461072
EXTRACTOR, BURNDY RX 20-10	6-59	0461043
EXTRACTOR, BURNDY RX 20-18	6-59	0461073
EXTRACTOR, BURNDY RX 4-1	6-59	0461044
EXTRACTOR, CARD, SYS 7	6-56	2704117
EXTRACTOR, ELECTROL TUBE	6-61	0460820
EXTRACTOR, LAMINAR BUS TAB	6-61	0461074
EXTRACTOR, LAMP	6-59	0461420
EXTRACTOR, PIN, AMP 3-5183	6-59	2108398
EXTRACTOR, WINCHESTER	6-59	0461060
FAN COVER, POWER CLEANER	10-83	9900552

## GROUP 20

## ALPHABETICAL INDEX

DESCRIPTION	GP-PG	PT NO.
FAN, POWER CLEANER	10-83	9900566
FE TOOL SET, LARGE-OLIVE	1-7	8550229
FE TOOL SET, SMALL-BLUE	1-8	8550227
FE TOOL SET, SMALL-BROWN	1-8	8550228
FELT PADS, TAPE CLEANER	10-85	0352605
FILE, HALF ROUND 6 IN., MED	5-52	0004013
FILE, HAND, 6 IN., KNIFE	5-51	4351141
FILE, HAND, 6 IN., HALF ROUND	5-51	4351137
FILE, HAND, 6 IN., ROUND	5-51	4351138
FILE, HAND, 6 IN., TRIANGLE	5-51	4351140
FILE, HAND, 8 IN., MILL	5-51	4351136
FILE, MILL 6 IN., MEDIUM	5-53	0004011
FILE, MILL, 6 IN., PILLAR, MED	5-53	0018974
FILE, MILL, 6 IN., ROUGH	5-53	4351166
FILE, RELAY CONTACT	5-52	0489076
FILE, ROUND- 4 IN., MEDIUM	5-52	4351049
FILE, ROUND- 6 IN., MEDIUM	5-52	0004014
FILE, ROUND- 6 IN., ROUGH	5-52	4351130
FILTER, VACUUM CLEANER	10-84	9900736
FINGER, MECHANICAL FLEXIBLE	6-55	0171320
FIRST AID KIT	9-77	0453693
FIRST AID KIT, SMALL	9-77	9900081
FLASHLIGHT	9-79	4261076
		9900585
FLASHLIGHT HEAVY DUTY	9-79	9900603
FLASHLIGHT MAGNETIC CLIP	9-79	9900604
FLEXSTONE	5-51	0165866
FLUX, 2 OX-BROWN	19-136	5392438
FOAM CLEANING CUBES	10-84	9900734
FOAM, CASSETTE RECORDER	17-126	1644326
FOLDER, WALLET TYPE	18-131	0453594
FOLDING SEAT	9-80	6339648
FOLDING TOOL, FLAT CABLE	14-104	2360383
FRAME, HAND HACKSAW	5-53	0450155
		0450432
FRAME, MANUAL B SIZE, 453147	15-117	0453149
FREEZE MIST BIASING AGENT	19-136	8549397
FREON, PCA, CLEANING AGENT	19-136	2200032
FUSE, 2 AMP, FOR 8020	16-123	4900655
FUSE, 2 AMP, FOR 8060A/AA	16-122	9900655
FUSE, 2.0 AMP, 3 AG SLO-BLO	15-114	0332003

## ALPHABETICAL INDEX

DESCRIPTION	GP-PG	PT NO.
FUSE,DYNAMIC TIMER	17-126	5442712
FUSE,SPARE,TRIPLETT 1 AMP	16-121	9900524
FUSE,SPARE,TRIPLETT 1/8"	16-121	9900588
GASKET,POWER CLEANER	10-83	9900538
GAUGE ASSEMBLY,SEL I/O	7-65	0453523
GAUGE ELEMENT,ESC/COMPOSER	7-67	9900533
GAUGE ELEMENT,EXECUTIVE MC	7-67	9900525
GAUGE SET,FEELER-METRIC	2-24	1749245
GAUGE,1403	7-66	0451893
GAUGE,1403/3,1403/N1	7-66	0452457
GAUGE,30" VAC,80" PRESSURE	8-73	5495385
GAUGE,ALIGNMENT	7-64	9900625
GAUGE,CARD FEED KNIFE	7-65	0010480
GAUGE,CARD HOPPER	7-64	0158333
GAUGE,CHUTE BLADE	7-63	0105668
GAUGE,DOT	7-64	1477925
GAUGE,DUPLICATING BRUSH	7-66	0454326
GAUGE,FEED KNIFE,.009" CARD	7-65	0450541
GAUGE,FEELER	7-63	9900468
GAUGE,FEELER .013"	7-63	1863715
GAUGE,FEELER- .05-1.0 MM	7-63	1749245
GAUGE,FEELER- 0.003"	7-63	2536581
GAUGE,FEELER- 0.004"	7-63	2536582
GAUGE,FEELER- 0.005"	7-63	2536583
GAUGE,FEELER- 0.007"	7-63	2598179
GAUGE,FEELER- 0.014"	7-63	2598041
GAUGE,FEELER- 0.016"	7-63	2598042
GAUGE,GRAM,0-50	8-72	2108612
GAUGE,INTERMITTENT ROLL	7-66	0608183
GAUGE,PNEUMATIC SYSTEM	8-74	2200040
GAUGE,PUNCH CARD	7-64	0450550
GAUGE,READER CLUTCH	7-66	0610147
GAUGE,THICKNESS,.001-.030"	7-63	0450745
GAUGE,THICKNESS,.015-.020"	7-63	0450544
GAUGE,WIRE- .005"	7-65	0453524
GAUGE,WIRE- .009"	7-65	0453525
GAUGE,WIRE- .010"	7-65	0453526
GAUGE,WIRE- .012"	7-65	0453527
GAUGE,WIRE- .015"	7-65	0453528
GAUGE,WIRE- .020"	7-65	0453530
GAUGE,WIRE- .028"	7-65	0453531
GEN. COUPLING 1311,1403	8-73	0451290
GEN. COUPLING 720,1443	8-73	0451921

## GROUP 20

## ALPHABETICAL INDEX

DESCRIPTION	GP-PG	PT NO.
GLOVES, LINEMAN'S SIZE 11	19-136	5715011
GLOVES, NYLON, LINT-FREE	19-136	0461621
GLOVES, PLASTIC	19-136	2200041
GLOVES, RUBBER-12 PR.	19-136	9900644
GRABBER PROBE, 6" RED	15-116	0489806
GRABBER, MINI TEST CLIP-BLK	16-120	8549385
GRABBER, MINI TEST CLIP-RED	16-120	1864853
GREASE GUN	11-86	1749267
GREASE GUN, VACUUM FED	11-86	9900578
GREASE GUN-SPRING LOADED	11-86	1864856
GREASE NOZZLE FOR 1864856	11-86	0450566
GREASE-SILICONE	19-136	0337539
GREASE-SILICONE, HEAT TRANS	19-136	0483151
GREASE-SILICONE, TUBE	19-136	0265390
GRIP RING, POWER CLEANER	10-83	9900551
		9900549
		9900550
		9900551
GRIPPER MAGNET	6-57	0489949
GROMMET, POWER CLEANER	10-83	9900558
GROUND LEAD, 12", LOGIC PROBE	16-123	8565942
GROUND LEAD, 3 IN.	15-111	5500902
GROUND LEAD, 5 IN. 127MM	15-114	0453168
GROUND LEAD, 5 INCH	15-111	5500900
GROUND LEAD, 5", LOGIC PROBE	16-123	5500900
GROUND LEAD, GEN LOGIC PROBE	16-118	5500900
GROUND TIP, SLT SCOPE PROBE	15-114	0453167
GUAGE, CARBON RIBBON	1-5	9900379
HAMMER	1-5	0489036
HAMMER, BALL PEEN- 2 OZ	3-41	9900076
HAMMER, BALL PEEN- 24 OZ	3-41	0450571
HAMMER, BALL PEEN- 4 OZ	3-41	1650874
HAMMER, BALL PEEN- 8 OZ	3-41	1650875
HAMMER, FLAT PEEN- 5 OZ	3-41	0489036
HAMMER, FLAT PEEN- 7 OZ	3-41	0489982
HAND CLEANER, 1 OZ PACKET	19-135	1354922
HAND CYCLE WHEEL	7-66	0900427
HANDLE, FILE	5-51	9900007
HANDLE, RATCHET	3-41	0451133
HANDLE, RATCHET, 1/4" DRIVE	2-23	1650887
HANDLE, SOCKET WRENCH, 1/4"	2-29	1650840
HANDLE, SOCKET WRENCH, SWIVEL	2-29	1650841

## ALPHABETICAL INDEX

GROUP 20

DESCRIPTION	GP-PG	PT NO.
HEADGEAR,WITH WINDOW	18-136	5715010
HEATING ELEMENT 110V,454332	12-88	0460194
HEATING ELEMENT 454332	12-88	1650786
HOLSTER,RADIO	18-131	9900507
HOMING,WRENCH 6240	7-68	0900627
HOOD,FOLDING VIEWING,454A	15-114	5500750
HOOK,FEED ROLL SPRING SCALE	8-72	0806533
HOOK,FOLDING VIEWING,453	15-114	0453201
HOOVEROMETER	1-5	9900575
	7-66	9900575
HOSE,POWER CLEANER	10-83	9900560
HOSE,PRESSURE,30"	8-73	2512794
HOSE,PRESSURE,8"	8-73	2512088
HOSE,VACUUM CLEANER	10-81	8549392
HULL,GRIPPER MAGNET	6-57	0489942
HUMISEAL,2 OZ-BROWN	19-136	5392435
HYDRAULIC OIL,GAL	19-136	2115252
HYDRAULIC OIL,QT	19-136	2164584
ILP POWER CONVERTERS,CSD	1-11	6428235
	1-17	6428235
	1-4	6428235
INDICATOR ASSEMBLY,DIAL	8-72	0450949
INDICATOR CARD ADAPTER,SMS	14-103	0453618
INDICATOR CARD,CASSETTE REC	17-126	1865015
INDICATOR CARD,CE LATCHED	14-108	0865015
INDICATOR CARD,LAMP,3752777	14-103	1143198
INDICATOR CARD,LAMP,5851882	14-103	5353889
INDICATOR CARD,LATCH-MST-1	14-103	5851882
INDICATOR CARD,LATCH-SLT	14-103	5801067
INDICATOR CARD,LATCH-SMS	14-103	0375277
INDICATOR,SPEED ROTATION	8-71	0152831
INK,BLUE,REC THERMOMETER	8-74	1749259
INK,RED,REC THERMOMETER	8-74	1749258
INSERT TOOL,AMP CONNECTOR	6-57	2127892
INSERT/EXTRACT TOOL	14-101	0453467
INSERT/EXTRACT TOOL,C-CLIP	1-5	0453521
	6-56	0453521
INSERT/EXTRACT TOOL,TROS	6-57	0453144
INSERTION TOOL,C CLIP	6-56	9900612
INSERTION TOOL,WIRE	6-57	9900206

## GROUP 20

## ALPHABETICAL INDEX

DESCRIPTION	GP-PG	PT NO.
INTEGRATED LOGIC PROBE	1-11	0453222
	1-17	0453222
	1-4	0453222
INTERGRATED LOGIC PROBE	16-123	0453222
IPAT ASSEMBLY,110V	17-125	1641153
IPAT ASSEMBLY,220V	17-125	1641154
IPAT JUMPER BLOCK	17-125	1641158
JACK,DYNAMIC TIMER	17-126	5442715
JUMPER ASM,2520-B	14-105	0829119
JUMPER ASM,SLT 18 IN.	14-105	0892118
JUMPER ASM,SLT 6 IN.	14-105	0829117
JUMPER,12 VOLT-SPECIAL	16-118	2728259
JUMPER,12",10K,GATE	16-123	8550208
JUMPER,12",LOGIC PROBE	16-123	2588263
JUMPER,SLT- 12",GEN LOGIC	16-118	2588263
KEY,HEX,.12IN. DIR.	2-32	0461137
KEY,LOCK CORBIN NO. 31	9-77	0460108
KEY,SOCKET HD SCR,.188"	2-32	0461275
KEY,SOCKET HD SCR,3/16"	2-32	0460947
KEYBUTTON PULLER	1-5	9900373
KEYLEVER TOOL,SEL & TYPEBAR	7-69	9900730
KIMWIPES- 15 X 17-5/8"	10-85	2123106
KIMWIPES- 5 X 8-3/4"	10-85	2162567
KIT ASM,RATCHET SCREWDRIVER	3-41	0451135
KIT ASM,TAPE CLEANER	10-85	0352465
KNEE PAD,12" X 17" X 1"	19-136	9900690
KNIFE,X-ACTO	14-101	0452561
LAB COAT L	19-135	4136379
LAB COAT XL	19-135	4136358
LABEL	17-126	5500748
LABEL,JAR	19-136	0450109
LACQUER,BLUE GRAY,715	19-136	0450936
LACQUER,CHARCOAL BROWN,734	19-136	4136933
LACQUER,CLASSIC BLUE,747	19-136	8324623
LACQUER,DARK GRAY,804	19-136	2108181
LACQUER,DEEP CHARCOAL,717	19-136	2108721
LACQUER,FLAME RED,716	19-136	5502806
LACQUER,GARNET ROSE,749	19-136	8324624
LACQUER,LIGHT GRAY,713	19-137	2108180
LACQUER,OFF WHITE,718	19-137	2744699
LACQUER,PEARL WHITE,719	19-137	0634779
LACQUER,PEARL WHITE,728	19-137	7367477

## ALPHABETICAL INDEX

GROUP 20

DESCRIPTION	GP-PG	PT NO.
LACQUER, PEBBLE GRAY, 733	19-137	1608809
LACQUER, RAVEN BLACK, 714	19-137	2108184
LACQUER, RAVEN BLACK, 724	19-137	0603717
LACQUER, SLATE GRAY, 736	19-137	4136932
LACQUER, SUNRISE YELLOW, 730	19-137	2108723
LACQUER, SUNRISE YELLOW, 735	19-137	4136934
LACQUER, WILLOW GREEN 748	19-137	8324621
LACQUIER, SKYBLUE, 720	19-137	5502807
LAMP, MAGNETIC BASE, 110 VAC	9-77	0453518
LAMP, REPLACEMENT, 48V LAMP	17-129	0316455
LATCH UNLATCH TOOL, BERG	15-110	0453705
LEADS, PROBE CLIPS 8020A	16-122	9900638
LIGHT, EXTENSION	9-77	0450147
		4261124
LINER, REPLACEMENT 5442867	19-137	5442868
LIQUID, ANTI-STATIC	19-137	2200118
LUBRICANT, CARD CONTACT, 4 OZ	19-138	0451053
LUBRICANT, DRUM BEARING, 1 LB	19-138	0471519
LUBRICANT, LB 300 X OIL, PT	19-138	2133355
LUBRICANT, LUBRIPLATE NO. 70	19-138	0453682
LUBRICANT, NO. 12 LITER	19-137	0771627
LUBRICANT, NO. 12, QT	19-137	0450133
LUBRICANT, NO. 15, PT	19-137	0450238
LUBRICANT, NO. 15, QT	19-137	0450052
LUBRICANT, NO. 17, 200 GRAM	19-137	0771821
LUBRICANT, NO. 17, LB	19-137	0450556
LUBRICANT, NO. 2, 1/4 OZ	19-137	1236595
LUBRICANT, NO. 20, 100 GRAM	19-137	0771874
LUBRICANT, NO. 20, LB	19-137	0117397
LUBRICANT, NO. 22, 100 GRAM	19-137	0771625
LUBRICANT, NO. 22, LB	19-137	0260781
LUBRICANT, NO. 23, 1 LB	19-137	1280442
LUBRICANT, NO. 23, 1/2 OZ	19-137	1280441
LUBRICANT, NO. 23, 8 OZ	19-137	9900692
LUBRICANT, NO. 24, LB	19-138	0450633
LUBRICANT, NO. 3, GAL	19-137	0477567
LUBRICANT, NO. 4, PT	19-137	0450669
LUBRICANT, NO. 4, QT	19-137	0450670
LUBRICANT, NO. 6, 6 OZ SPRAY	19-137	0451110
LUBRICANT, NO. 6, GAL	19-137	0450315
LUBRICANT, NO. 6, PT	19-137	0223980
LUBRICANT, NO. 7, PT	19-137	2127714



## GROUP 20

## ALPHABETICAL INDEX

DESCRIPTION	GP-PG	PT NO.
LUBRICANT,NO. 9,PT	19-137	0450668
LUBRICANT,NO. 9,QT	19-137	0450676
LUBRICANT,PIN	19-138	0453391
MAGNETIC TAP DEVELOPER	19-138	9900418
MAGNIFIER,LIGHTED	9-79	0452642
MALE COAX FEMALE 6-32 CONN	15-110	0453954
MANOMETER,PRESSURE GAUGE	8-72	5258784
MARKER,MAGNETIC TAPE	19-138	0352407
MAT,ESD	14-99	6428274
METER CASE,TRIPLETT	16-121	9900193
METER LEAD SET	16-120	6428104
METER LEAD SET,COLINE	1-11	6428104
	1-17	6428104
	1-4	6428104
METER LEAD,BLACK	16-122	1749253
METER LEAD,RED	16-122	1749252
METER LEAD,REPAIR STUDS-BLACK	16-122	8549388
METER LEAD,REPAIR STUDS-RED	16-122	8549389
METER LEAD,TEST-BLACK,8022	16-122	1762921
METER LEAD,TEST-RED	16-122	1762920
METER LEAD-BLACK	16-120	7838690
METER LEAD-RED	16-120	7838689
METER,DATA PRECISION 258	16-124	1749232
METER,TRIPLETT	1-22	9900167
	16-120	9900167
METRIC B/M	2-24	1749235
MICROFICHE CASE	9-79	1851978
MID-AIR SPLICE, QTY 4	14-107	2360370
MINI PROBE BNC CONN	15-111	6428059
MINI PROBE CABLE ASM	15-111	6428064
MINI PROBE GROUND LEAD,20 CM	15-111	6428114
MINI PROBE TIP ASM	15-111	6428066
MINIPROBE ASM,BERG	15-110	0453718
MOLYCOTE G RAPID,2 OZ	19-138	5144304
MOLYCOTE,1 LB	19-138	8026752
MOLYCOTE,350B,10 GRAM TUBE	19-138	0771494
MOLYCOTE,BR2,100 GRAM CAN	19-138	0771847
MOLYCOTE,TUBE,TYPE G-N PASTE	19-138	1280018
MOLYCOTE,TYPE G	19-138	0357830
MULTIMETER,ANALOG	1-11	9900167
	1-17	9900167

## ALPHABETICAL INDEX

GROUP 20

DESCRIPTION	GP-PG	PT NO.
MULTIMETER, ANALOG	1-4	9900167
MULTIMETER, DIGITEC, 2210	16-124	1749233
MULTIMETER, FLUKE 8020 B/AF	16-123	9900628
MULTIMETER, FLUKE, 8020 B/AF	1-11	9900628
	1-17	9900628
	1-4	9900628
MULTIMETER, FLUKE, 8060 A/AA	1-11	8496278
	1-17	8496278
	1-4	8496278
	16-122	8496278
NOZZLE, LONG	11-86	0450813
NOZZLE, POWER CLEANER	10-83	9900559
NOZZLE, SHORT	11-86	9900271
OIL CARTRIDGE, LUBRICANT	19-138	1797703
OIL DROPPER	11-86	4261101
OIL STONE	5-52	4690840
OIL, CLOCK MOTOR, 1 OZ, NO. 28	19-138	2115444
OIL, IBM 10, 1 PT CAN	19-138	1280444
OIL, IBM 10, 4 OZ BOTTLE	19-138	1280443
OILER EXTENSION, FOR 153778	11-86	0450443
OILER NOZZLE, HAND	11-86	0450014
OILER, HAND RESERVOIR 1/2 OZ	11-86	0450713
OILER, HAND, 6 OZ, PISTOL	11-86	0153778
OPTICAL COMPARATOR	17-129	9900463
OSCILLOSCOPE HOOD, 454A	15-112	5500750
OSCILLOSCOPE, 2335, 100MHZ	15-113	6428880
OSCILLOSCOPE, 2445, 150MHZ	15-113	6248881
OSCILLOSCOPE, 2465, 300MHZ	15-113	6428882
OSCILLOSCOPE, 454A	15-112	0453550
OSCILLOSCOPE, 465A	15-112	0453214
OSCILLOSCOPE, 475A	15-112	0453215
OSCILLOSCOPE, 475A WITH DM44	15-112	1650782
PAD HOLDER (TAPE CLEANER)	10-85	0352606
PAINT, SILVER CONDUCTIVE	19-138	0641458
PAPER SLEEVES	19-138	8496274
PARTS CADDY, CONDUCTIVE SOFT	18-134	6428141
PEN, CLEANING, HOT ROLL	10-84	1294241
PEN, FRONT, THERMOMETER	8-74	1749256
PEN, REAR, THERMOMETER	8-74	0749257
PERFORATOR, PAPER, 22-HOLES	9-77	0512893

DESCRIPTION	GP-PG	PT NO.
PICK,SEGMENT	10-81	9900004
PIN PUNCH .062 X 4"	6-60	9900084
PIN RE KIT BOX	14-102	0451148
PIN RE KIT DRIFT DRIVER BIT	14-102	0453135
PIN RE KIT DRILL NO. 53	14-102	0450262
PIN RE KIT DRILL NO. 56	14-102	0453037
PIN RE KIT DRIVER RE PIN	14-102	0453774
PIN RE KIT EMBOSSING BIT	14-102	0452617
PIN RE KIT EXTENSION	14-102	0453390
PIN RE KIT IMPACT TOOL	14-102	0452616
PIN RE KIT LOCATING BLOCK	14-102	0453778
PIN RE KIT LONG DRIVER BIT	14-102	0453112
PIN RE KIT MST-SLT	14-102	0453428
PIN RE KIT REAMER 0.050"	14-102	0453773
PIN RE KIT SHORT DRIVER BIT	14-102	0452618
PIN RE KIT VIAL,0.515 D	14-102	0453443
PIN RE KIT VIAL,0.515 S	14-102	0453444
PIN TIP,6-32	16-118	0461091
PIN,IPAT ASM	17-125	5362303
PIN,MOTOR,POWER CLEANER	10-83	9900572
PLASTIC MIRROR,DENTAL	9-79	0450126
PLASTIC POLISH	19-138	9900177
PLASTIC SPRAY,12 OZ	19-138	0450936
PLATE,VALVE,POWER CLEANER	10-83	9900539
PLATEN POSITION ADJ. SEL	7-65	9900519
PLIERS,ADJUSTING	4-47	0489017
PLIERS,BEAD CLOSING	4-47	0343641
PLIERS,CHAIN NOSE,4-1/2"	4-45	0450786
PLIERS,CLIP INSERTING	4-48	0461158
PLIERS,DIA. CUT,4" SPRINGS	4-45	9900688
PLIERS,DIA. CUT,SOFT WIRE	4-45	1650865
PLIERS,DUCK BILL,8"	4-45	1650864
PLIERS,GAS	4-45	9900064
PLIERS,GRIP RING 2314	4-47	2200101
PLIERS,GRIP RING-LARGE	4-46	9900714
PLIERS,GRIP RING-SMALL	4-46	9900317
PLIERS,LONG NOSE,8 IN.	4-45	0460808
PLIERS,LONG NOSE,ROUND 6"	4-45	1650866
PLIERS,NEEDLE NOSE,6-1/2"	4-47	0460807
PLIERS,PEENING	4-48	9900268
PLIERS,POLYGRIP	4-47	0489905
PLIERS,RET RING,BENT TIPS	4-46	0460622
PLIERS,RET RING,ST. TIPS	4-46	1864854

## ALPHABETICAL INDEX

GROUP 20

DESCRIPTION	GP-PG	PT NO.
PLIERS,RETAINING CLIP	4-46	0489967
		0489969
		0489968
PLIERS,TAPER PIN PULLING	4-46	9900521
PLIERS, VISE GRIP	4-47	0453198
PLIERS,WIRE STRIPPER NO. 30	14-101	0452528
PLUG	16-124	1647116
PLUG,EIA-CITT CABLE WRAP	17-129	1644320
PLUG,INSULATED BANANA-BLACK	15-116	1749248
PLUG,INSULATED BANANA-RED	15-116	1749247
PLUG,OHMMETER	16-122	0453555
POSITIONING TOOL,TRI-LEAD	14-105	2360406
POST,JACK	15-114	0453185
POUCH,CANVAS,SOCKET KEYS	18-131	0450467
	2-30	0450467
POWER CLEANER	1-22	9900534
POWER DEL HANDLE	14-101	0453134
POWER DEL HANDLE,ADAPTER	14-101	0453588
POWER DEL HANDLE,FILTER	14-101	0453064
POWER DEL HANDLE,GEAR	14-101	0453085
POWER DEL HANDLE,MOTOR	14-101	0453084
POWER DEL HANDLE,RECTIFIER	14-101	0453766
POWER DEL HANDLE,RING	14-101	0453066
POWER DEL HANDLE,SPONGE	14-101	0453067
POWER DEL HANDLE,VACUUM	14-101	0453063
POWER MODULE (LOGIC PROBE)	16-123	6428235
PRINTWHEEL HOMING PLATE	7-69	9900624
PROBE ASM,GROUND AND SIGNAL	15-110	0453915
PROBE HOLDER	15-111	5500899
	15-114	0453179
PROBE TIP,FEMALE,ASLT MSTX	14-104	0453834
PROBE TIP,FLAG,SCT	16-123	0453826
PROBE TIP,MALE,ASLT MSTX	14-104	0453836
PROBE TIP,MST-2-4	14-102	0453888
PROBE TIP,MSTX	14-104	0453446
PROBE TIP,SLT 6-32	14-104	0453826
PROBE TIP,SLT MST 1-2 SGL	14-104	0453225
PROBE TIP,STRAIGHT,SCT	16-123	0453167
PROBE TO 6/32 ADAPTERS	16-118	5500901
PROBE,1/8" X 4 1/2" NYLON	10-85	2507587

## GROUP 20

## ALPHABETICAL INDEX

DESCRIPTION	GP-PG	PT NO.
PROBE,10 X 100MHZ P-6105	15-109	1650764
PROBE,10 X 100MHZ P-6108	15-109	1650882
PROBE,10 X 250MHZ	15-109	1650776
PROBE,10 X 250MHZ 2M CABLE	15-109	1650762
PROBE,10 X 250MHZ BODY	15-109	1650761
PROBE,10 X 250MHZ COMP BOX	15-109	1650778
PROBE,100 NS SLD-MTS SYS/3	16-122	0817971
PROBE,1X,P-1601	15-109	1650767
PROBE,BANANA PLUG CONN	15-116	4261006
PROBE,GEN LOGIC	16-118	0453212
PROBE,HOOK-BLACK	16-120	7838683
PROBE,HOOK-RED	16-120	7838682
PROBE,HV,BLACK	16-120	7838685
PROBE,HV,BLACK,6/32"	16-121	1749250
PROBE,HV,RED	16-120	7838684
PROBE,HV,RED,6/32"	16-121	1749249
PROBE,NEON 029/059	16-118	0452803
PROBE,P-6034,10X	15-109	0453548
PROBE,P-6101 2M CABLE	15-109	1650762
PROBE,P-6101 BODY	15-109	1650765
PROBE,P-6105 2M CABLE	15-109	1650762
PROBE,P-6105 BODY	15-109	1650761
PROBE,P-6105 COMP BOX	15-109	1650763
PROBE,P-6108 2M CABLE	15-109	1650762
PROBE,P-6108 BODY	15-109	1650761
PROBE,P-6108 COMP BOX	15-109	1650763
PROBE,P6022,CURRENT,9'	15-111	5500903
PROBE,YELLOW,8/32" TRIPLETT	16-121	6428897
PULLER,DOWEL PIN,1/4-20 NC	6-56	0450554
PULLER,DOWEL PIN,10-32/5-40	6-56	0450054
PULLER,FUSE	6-60	0450935
PULLER,GEAR AND WHEEL	6-57	0450365
PULLER,REED RELAY AND FUSE	6-60	0452397
PULLER,RELAY	6-60	0454065
PULLER,SMS CARD,SINGLE	6-61	0451030
PULLER/INSERTER,CLIP	6-56	0450108
PUMPHEAD,POWER CLEANER	10-83	9900536
PUNCH DR. PIN,.187 X 4"	6-60	0004035
PUNCH,CENTER	6-58	0004031
PUNCH,DR. PIN,.050 X 3-1/2"	6-60	0450448
PUNCH,DR. PIN,.055 X 10.5"	6-60	0605908
PUNCH,DR. PIN,.060 X 6"	6-60	0460315
PUNCH,DR. PIN,.0625 X 4"	6-60	0450407

## ALPHABETICAL INDEX

GROUP 20

DESCRIPTION	GP-PG	PT NO.
PUNCH,DR. PIN,.094 X 4"	6-60	0450391
PUNCH,DR. PIN,.75 X 41"	6-60	0650013
PUNCH,DR. PIN,1/4 X 8"	6-60	0157198
PUNCH,DR. PIN,1/8 X 10"	6-60	0004032
PUNCH,DR. PIN,1/8 X 8" SPL	6-60	0460303
PUNCH,DR. PIN,3/16 X 18"	6-60	0157199
PUNCH,DR. PIN,3/32 X 18"	6-60	0157200
PUNCH,DR. PIN,3/32 X 8" SPL	6-60	0450456
PUNCH,DR. PIN,9/32 X 8" SPL	6-60	0450457
PUNCH,ROLL PIN	6-60	1978459
PUNCH/DIE,KNOCKOUT- 1-1/16"	6-58	0450514
PUNCH/DIE,KNOCKOUT- 1-3/8"	6-58	0460169
PUNCH/DIE,KNOCKOUT- 7/8"	6-58	0460139
Q-TIPS (PACKAGE OF 100)	10-84	1244747
RAGS	19-138	1650800
RAGS (50 PER BOX)	10-85	1650800
REAMER/TAPER,T-BAR-NO. 0	13-96	0450008
REAMER/TAPER,T-BAR-NO. 1	13-96	0173257
REAMER/TAPER,T-BAR-NO. 2	13-96	0173258
REAMER/TAPER,T-BAR-NO. 2/0	13-96	0450001
REAMER/TAPER,T-BAR-NO. 3	13-96	0173259
REAMER/TAPER,T-BAR-NO. 3/0	13-96	0450057
REAMER/TAPER,T-BAR-NO. 4	13-96	0157919
REAMER/TAPER,T-BAR-NO. 5/0	13-96	0167718
REAMER/TAPER-NO. 0	13-95	0008955
REAMER/TAPER-NO. 1	13-95	0008956
REAMER/TAPER-NO. 2	13-95	0008957
REAMER/TAPER-NO. 2/0	13-95	0055797
REAMER/TAPER-NO. 3	13-95	0008958
REAMER/TAPER-NO. 3/0	13-95	0450134
REAMER/TAPER-NO. 4	13-95	0450270
REAMER/TAPER-NO. 4/0	13-95	0055798
REAMER/TAPER-NO. 5	13-95	0450269
REAMER/TAPER-NO. 5/0	13-95	0055799
REAMER/TAPER-NO. 6/0	13-95	0055800
REAMER/TAPER-NO. 7/0	13-95	0450017
REDUCED FN TOOL,HALF CYCLE	7-65	0453604
REMOVAL TOOL	14-99	0453824
REMOVAL TOOL,KEYBUTTON	6-59	9900373
REMOVAL TOOL,KEYTOP	6-59	0627953
REMOVAL TOOL,PIN 2321	6-60	0220026
REMOVAL TOOL,SEL CAM FOLLOW	6-56	9900709
REMOVAL TOOL,SETSCREW	13-90	9900605

## GROUP 20

## ALPHABETICAL INDEX

DESCRIPTION	GP-PG	PT NO.
REMOVAL TOOL, STORAGE JUMPER	6-59	2108860
REPLACEMENT BAG'S, VACUUM	10-81	1646826
REPLACEMENT BLADE, 1-1/2"	3-40	1650871
REPLACEMENT BLADE, 1/4 X 6"	3-40	1650861
REPLACEMENT BLADE, 1/8 X 4"	3-40	1650858
REPLACEMENT BLADE, 1/8 X 8"	3-40	1650859
REPLACEMENT BLADE, 10"	3-40	1650862
REPLACEMENT BLADE, 3/16 X 6"	3-40	1650860
REPLACEMENT BLADE, 5/16 X 6"	3-40	1650863
REPLACEMENT HANDLE, PERF	9-77	5373499
REPLACEMENT PALLET	1-22	9900621
REPLACEMENT SPOUT, LONG	11-86	9900374
RESERVOIR 1 OZ.	11-86	9900106
RETRACTABLE HOOK TIP	15-111	5500898
RETRIEVER TELESCOPIC MAGNET	6-58	9900727
RIBBON, CLEANING	19-138	0461305
RING, INSULATING, FOR 453161	15-114	0453189
ROLL, TYPE BAR	18-132	9900073
ROTATE SELECTION ADJ. TOOL	7-67	9900633
RULER 200 MM, 8"	8-71	0489185
SAFETY SPECTACLES 65% DARK	17-128	4261094
SCALE ASM, GRAM	8-71	0450459
SCALE, 150 MM	2-24	1749246
SCALE, METRIC- 150MM	8-71	1749246
SCALE, POCKET, 6"	8-71	0450158
SCALE, PUSH-PULL 0-6 LB	8-71	0460870
SCALE, PUSH-PULL, 0-10 LB	8-71	0461141
SCALE, SPRING 2.5 KG	8-72	0489898
SCISSOR, CLAMP STRAIGHT TIP	4-45	9900233
SCISSOR, CLAMP CURVED TIP	4-45	0452368
SCOPE ACCESSORY, MINI PROBE	15-110	7838680
SCOPE, TEKTRONIX 453	15-114	0453047
SCREW ADAPTER, 1/4"	3-41	0451130
SCREW ADAPTER, 3/16"	3-41	1650758
SCREW ADAPTER, 3/8"	3-41	0451131
SCREW, NYLON, DYNAMIC TIMER	17-126	5442710
SCREW, POWER CLEANER	10-83	9900564
		9900563
		9900565
		9900562
		9900561
SCREWDRIVER	3-42	8021710

## ALPHABETICAL INDEX

GROUP 20

DESCRIPTION	GP-PG	PT NO.
SCREWDRIVER ADAPTER, TORQUE	8-75	2597970
SCREWDRIVER ALIGNMENT TOOL	3-42	2108766
SCREWDRIVER ASM, JEWELER	3-42	0461228
SCREWDRIVER BIT, 6 FL, NO. 6	3-39	9900609
SCREWDRIVER BIT, 6 FL, NO. 8	3-39	9900041
SCREWDRIVER BIT, HYDRAULIC	3-43	4261079
SCREWDRIVER BIT, PHIL NO. 2	3-39	9900721
SCREWDRIVER BIT- LARGE	3-39	9900723
SCREWDRIVER BIT- NO. 1 PHIL	3-39	9900720
SCREWDRIVER BIT- NO. 1 SUPA	3-39	9900766
SCREWDRIVER BIT- NO. 2 PHIL	3-39	9900721
SCREWDRIVER BIT- NO. 2 SUPA	3-39	9900767
SCREWDRIVER BIT- SMALL	3-39	9900722
SCREWDRIVER BLADE, JEWELER-LG	3-42	9900364
SCREWDRIVER BLADE, JEWELER-SM	3-42	9900363
SCREWDRIVER KIT, PHIL/STD	3-41	0460258
SCREWDRIVER, 1/4 X 1-1/2"	3-40	4057150
SCREWDRIVER, 1/4 X 10"	3-40	4057143
SCREWDRIVER, 1/4 X 6"	3-40	1650854
SCREWDRIVER, 1/8 X 4"	3-40	4357142
SCREWDRIVER, 1/8 X 8"	3-40	1650852
SCREWDRIVER, 3"	3-39	9900070
SCREWDRIVER, 3.0" W/CLIP	3-40	9900070
SCREWDRIVER, 3/16 X 3"	3-40	1857019
SCREWDRIVER, 3/16 X 6"	3-40	1650853
SCREWDRIVER, 3/32 X 3"	3-40	1857020
SCREWDRIVER, 5/16 X 8"	3-40	1650856
SCREWDRIVER, 5/16 X 9"	3-40	8549394
SCREWDRIVER, 6 FLUTE, .110	2-30	0460812
SCREWDRIVER, 6 FLUTE, NO. 6	3-39	9900608
SCREWDRIVER, 6 FLUTE, NO. 8	3-39	9900040
SCREWDRIVER, ALGN 6240	7-68	9900626
SCREWDRIVER, ALGN, FIBER PROBE	3-43	0460811
SCREWDRIVER, BIT (TORQUE)	8-73	0848205
SCREWDRIVER, EXT-NO. 10, 6 FL	2-30	0450721
SCREWDRIVER, EXT-NO. 5, 4 FL	2-30	0450722
SCREWDRIVER, HEX, 1.27 MM	2-30	8021711
SCREWDRIVER, JEWELER-LARGE	3-42	9900362
SCREWDRIVER, JEWELER-SMALL	3-42	9900361
SCREWDRIVER, MAG. 4" BLADE	3-39	9900712
SCREWDRIVER, OFFSET	3-42	0489146
		0489136
SCREWDRIVER, PHILLIPS- NO. 2	3-42	2197195



**GROUP 20      ALPHABETICAL INDEX**

<b>DESCRIPTION</b>	<b>GP-PG</b>	<b>PT NO.</b>
SCREWDRIVER,TIP 1.45"	3-39	9900713
SCREWDRIVER,TORQUE	8-75	2286679
SCREWDRIVER,TORQUE TIP #4	8-73	0453568
SCREWDRIVER,TORQUE,0-48	8-73	0453570
SCREWDRIVER,TORQUE,0-6	8-73	0461450
SCREWDRIVER,TORQUE,BIT	8-73	0848204
SCREWSTARTER,2 1/2"	3-43	9900686
SCREWSTARTER,LARGE	3-40	9900328
SCREWSTARTER,QUICK WEDGE,6"	3-43	9900337
SCREWSTARTER,SMALL	3-40	9900060
SCREWSTARTER,WEDGE 8-1/2"	3-40	9900212
SEALANT,LOCITE TYPE A,2 CC	19-138	0216348
SEALANT,SILICONE,5280	19-138	0889524
SELECTRIC I/O TOOL	1-5	9900459
SHOP COAT	19-136	9900590
SHOP COAT L	19-136	9900591
SHOP PANTS L	19-136	9900643
SHOP PANTS M	19-136	9900642
SHOP SHIRT L	19-136	9900641
SHOP SHIRT M	19-136	9900640
SKIN CREME,MONO DERMIN	19-138	0450405
SLEEVE,CUTTER REPAIR	14-98	0452568
SLT TIP	16-118	0453826
SLT TIP,GROUND	16-118	0453167
SMOCK,EXTRA LARGE	19-138	1650977
SMOCK,EXTRA SMALL	19-138	1650976
SMOCK,LARGE	19-138	0289275
SMOCK,MEDIUM	19-138	0289274
SMOCK,SMALL	19-138	0289273
SMS BACK PANEL PROBE,NYLON	14-98	0461262
SOCKET ADPT HEX HD,1/4-3/8"	2-29	7030589
SOCKET ADPT HEX HD,5/16-3/8"	2-29	2108040
SOCKET ADPT HEX HD,5/32-3/8"	2-29	2108914
SOCKET ADPT HEX HD,6MM-3/8"	2-29	4463820
SOCKET ADPT HEX HD,7/64-1/4"	2-29	0453397
SOCKET ADPT HEX HD,9/64-1/4"	2-29	2200161
SOCKET ADPT,3/8 - 1/4" DR	2-29	1805216
SOCKET KEY,4 FLUTE- .047"	2-34	9900173
	2-36	9900173
		2108498
SOCKET KEY,4 FLUTE- .090"	2-36	0112646
SOCKET KEY,4 FLUTE- .109"	2-36	0123789

## ALPHABETICAL INDEX

GROUP 20

DESCRIPTION	GP-PG	PT NO.
SOCKET KEY,4 FLUTE- .131"	2-36	0152857
SOCKET KEY,4 FLUTE- 0.76"	2-34	0450815
SOCKET KEY,4 FLUTE- 5/64"	2-37	0450815
SOCKET KEY,4 FLUTE- NO.4	2-34	9900204
	2-36	9900024
	2-37	9900204
SOCKET KEY,4 FLUTE- NO.5	2-34	9900066
	2-36	9900066
	2-37	9900066
SOCKET KEY,4 FLUTE- NO.6	2-34	9900101
	2-36	9900101
	2-37	9900101
SOCKET KEY,6 FLUTE- .047"	2-33	9900216
	2-34	9900216
	2-36	9900216
SOCKET KEY,6 FLUTE- .060"	2-33	9900028
	2-34	9900028
	2-36	9900028
SOCKET KEY,6 FLUTE- .070"	2-33	9900200
	2-34	9900200
	2-36	2200051
SOCKET KEY,6 FLUTE- .072"	2-36	9900200
SOCKET KEY,6 FLUTE- .094"	2-33	9900102
	2-34	9900102
	2-36	2108626
		9900102
SOCKET KEY,6 FLUTE- .110"	2-33	9900103
	2-34	9900103
	2-36	9900103
SOCKET KEY,6 FLUTE- .132"	2-36	9900255
SOCKET KEY,6 FLUTE- .133"	2-33	9900255
	2-34	9900255
SOCKET KEY,6 FLUTE- .143"	2-36	0450050
SOCKET KEY,6 FLUTE- .168"	2-33	0452395

## GROUP 20

## ALPHABETICAL INDEX

DESCRIPTION	GP-PG	PT NO.
SOCKET KEY,6 FLUTE- .168"	2-36	0452395
SOCKET KEY,6 FLUTE- .250"	2-34	9900029
SOCKET KEY,6 FLUTE- .312"	2-34	9900019
	2-36	9900019
SOCKET KEY,6 FLUTE- 1/4"	2-37	9900029
SOCKET KEY,6 FLUTE- 5/16"	2-37	9900019
SOCKET KEY,6 FLUTE- NO.10	2-37	9900103
SOCKET KEY,6 FLUTE- NO.133	2-37	9900255
SOCKET KEY,6 FLUTE- NO.2	2-37	9900216
SOCKET KEY,6 FLUTE- NO.4	2-37	9900028
SOCKET KEY,6 FLUTE- NO.6	2-36	9900029
	2-37	9900200
SOCKET KEY,6 FLUTE- NO.8	2-37	9900102
SOCKET KEY,FLUTE- NO.2	2-37	9900173
SOCKET KEY,HEX- .028"	2-33	2108315
	2-35	2108315
SOCKET KEY,HEX- .035"	2-35	0452220
SOCKET KEY,HEX- .050"	2-33	0074925
	2-34	9900062
	2-35	0074925
		9900062
		0460314
SOCKET KEY,HEX- .058"	2-35	9900717
SOCKET KEY,HEX- .062"	2-33	0077009
	2-35	0077009
		0460313
SOCKET KEY,HEX- .077"	2-33	0450372
	2-35	9900716
		0460312
SOCKET KEY,HEX- .093"	2-33	0450373
	2-34	0450373
	2-35	0450373
SOCKET KEY,HEX- .097"	2-35	9900715
SOCKET KEY,HEX- .108"	2-33	2108490
	2-34	2108490

## ALPHABETICAL INDEX

DESCRIPTION	GP-PG	PT NO.
SOCKET KEY,HEX- .108"	2-35	2108490
SOCKET KEY,HEX- .118"	2-35	1749238
SOCKET KEY,HEX- .125"	2-33	0116574
	2-34	0116574
	2-35	0116574
SOCKET KEY,HEX- .140"	2-33	0451553
	2-34	0451553
	2-35	0451553
SOCKET KEY,HEX- .155"	2-33	0007231
	2-35	0007231
SOCKET KEY,HEX- .156"	2-34	9900339
SOCKET KEY,HEX- .187"	2-33	0178397
	2-34	0178397
	2-35	0178397
SOCKET KEY,HEX- .196"	2-35	1749237
SOCKET KEY,HEX- .218"	2-35	0450038
SOCKET KEY,HEX- .236"	2-35	1749236
SOCKET KEY,HEX- .250"	2-35	0450453
SOCKET KEY,HEX- .312"	2-35	0450454
SOCKET KEY,HEX- .375"	2-35	0450455
SOCKET KEY,HEX- 1/8"	2-37	0116574
SOCKET KEY,HEX- 3/16"	2-37	0178397
SOCKET KEY,HEX- 3/32"	2-37	0450373
SOCKET KEY,HEX- 5/32"	2-37	9900339
SOCKET KEY,HEX- 500"	2-35	2108467
SOCKET KEY,HEX- 7/64"	2-37	2108490
SOCKET KEY,HEX- 9/64"	2-37	0451553
SOCKET KEY,HEX- NO.2	2-34	9900358
	2-35	9900358
	2-37	9900358
SOCKET KEY,HEX- NO.4	2-37	9900062
SOCKET KEY,HEX- NO.6	2-34	9900202
	2-35	9900202
	2-37	9900202
SOCKET KEY,HEX- NO.8	2-34	9900058
	2-35	9900058

## GROUP 20

## ALPHABETICAL INDEX

DESCRIPTION	GP-PG	PT NO.
SOCKET KEY,HEX- NO.8	2-37	9900058
SOCKET WRENCH,6 POINT,10 MM	2-24	1749240
SOCKET WRENCH,6 POINT,13 MM	2-24	1749241
SOCKET WRENCH,6 POINT,5 MM	2-24	1857021
SOCKET WRENCH,6 POINT,6 MM	2-24	1749262
SOCKET WRENCH,6 POINT,7 MM	2-24	1749239
SOCKET WRENCH- 1/2"	2-24	1650838
SOCKET WRENCH- 1/4"	2-24	1650833
SOCKET WRENCH- 10 MM	2-24	1749240
SOCKET WRENCH- 11/32"	2-24	1650835
SOCKET WRENCH- 13 MM	2-24	1749241
SOCKET WRENCH- 3/16"	2-24	1650831
SOCKET WRENCH- 3/8"	2-24	1650836
SOCKET WRENCH- 5 MM	2-24	1857021
SOCKET WRENCH- 5/16"	2-24	1650834
SOCKET WRENCH- 6 MM	2-24	1749262
SOCKET WRENCH- 7 MM	2-24	1749239
SOCKET WRENCH- 7/16"	2-24	1650837
SOCKET WRENCH- 7/32"	2-24	1650832
SOCKET WRENCH- 9/16"	2-24	1650839
SOCKET WRENCH-KEY PUNCH	2-30	0489174
SOCKET,CASTER,453147 CART	15-117	0453549
SOCKET,UNIVERSAL,1/4" DRIVE	2-29	1650842
SOLDER	12-87	9900026
SOLDER ELEMENT,27 WATT	12-88	9900382
SOLDER PASTE,50-50	19-139	0641462
SOLDER,LEAD/TIN ALLOY	12-87	2102025
SOLDER,ROSIN CORE	19-139	0353887
SOLDER,WICK	12-87	5151439
SOLDERING AID	12-87	5230032
SOLDERING FLUX,PASTE	12-87	0004055
SOLDERING IRON,110V	12-87	0454332
SOLDERING IRON,16W	12-87	0489882
SOLDERING IRON,16W 200V	12-87	0489881
SOLDERING IRON,16W,115V	1-11	0489882
	1-4	0489882
SOLDERING IRON,16W,220V	1-11	0489881
	1-4	0489881
SOLDERING TIP	1-11	0489883
	1-4	0489883

## ALPHABETICAL INDEX

GROUP 20

DESCRIPTION	GP-PG	PT NO.
SOLDERING TIP	12-87	0489883
SOLDERING TIP 50 WATT CMPT	12-88	9900016
SOLDERING TIP,PENCIL 1/8"	12-88	1650787
SOLDERING TIP,PYRAMIC 5/16"	12-88	1650788
SOLVENT,91% ISOPROPYL ALC	19-139	2200200 2155966
SOLVENT,ALCOHOL PAD	19-139	9900679
SOLVENT,CLEANER	19-139	2286522
SOLVENT,CLEANER,COVER,8 OZ	19-139	0450891
SOLVENT,IBM CLEANING FLUID	19-138	1280017
SOLVENT,IBM CLEANING,6 OZ	19-138	0450608
SOLVENT,LETTERING	19-138	2106774
SPACER,POWER CLEANER	10-83	9900540
SPINNER 1/4 X 5/16"	2-25	9900242
SPONGE,CLEANING	19-139	9900050
SPOUT,CLEANING FLUID CAN	18-132	9900178
SPRING HOOK,CAPTIVE	6-55	9900210
SPRING HOOK,CUSHIONED	6-55	9900254
SPRING HOOK,HEAVY DUTY	6-55	9900635
SPRING HOOK,LARGE	6-55	9900059
SPRING HOOK,SMALL	6-55	9900105
SPRING HOOK,SMALL CROCHET	6-55	0450540
SPRING HOOK,SPECIAL	6-55	0450030
SPRING WASHER,POWER CLEANER	10-83	9900548
SPRING,POWER CLEANER	10-83	9900574
STATOR,POWER CLEANER	10-83	9900545
STICK,EMERY POLISHING	5-53	0450503
STONE,BRUSH SEATING	5-52	0450426
STONE,SHARPENING	5-53	0018463
STOP,WIRE STRIPPER	4-47	0461076
STRAIGHT PROBE TIP PIN	16-123	8550205
STRAP,HAND MICROFILM VIEWER	9-79	1851977
STRIPPER,WIRE	14-98	0450694
STROBE ASM	17-128	4261074
STROBOSCOPE,IBM	17-126	0453600
SUPADRIVE 6" BLADE	3-39	4760541
SUPADRIVE 8" BLADE	3-39	4760542
SWITCH,POWER CLEANER	10-83	9900570
SYRINGE,056	10-84	1477752
T BENDER	7-68	9900094
TACH,CAPACITOR 5444	8-73	2600559

## GROUP 20

## ALPHABETICAL INDEX

DESCRIPTION	GP-PG	PT NO.
TACH, GENERATOR CARRIAGE	8-73	0450978
TACH. BRACKET 5444	8-73	2538137
TACH. COUPLING 5444	8-73	2538084
TACH/GEN, SHAFT ADAPTER 1287	8-73	0667329
TACHOMETER HAND, 1 RANGE	8-72	0451126
TACHOMETER, ELECTRIC GEN	8-72	0461117
TACHOMETER/GEN, ELECTRIC	8-75	0450919
TAP, BOTTOMING- 6-32	13-95	0616185
TAP, EXTENTION- 1/4-20	13-93	0178667
TAP, EXTENTION- 10-32	13-93	0450011
TAP, EXTENTION- 8-32	13-93	0158220
TAP, THREADING- 1/4-20 UNC	13-96	0178667
TAP, THREADING- 10-32 UNF	13-96	0450011
TAP, THREADING- 8-32 UNC	13-96	0158220
TAP, THREADING-INCH 1/4-20	13-89	0450172
TAP, THREADING-INCH 1/4-24	13-89	0055759
TAP, THREADING-INCH 1/4-28	13-89	0450273
TAP, THREADING-INCH 10-24	13-89	0055754
TAP, THREADING-INCH 10-30	13-89	0055755
TAP, THREADING-INCH 10-32	13-89	0004010
TAP, THREADING-INCH 12-24	13-89	0055757
TAP, THREADING-INCH 14-24	13-89	0450171
TAP, THREADING-INCH 2-56	13-89	0055746
TAP, THREADING-INCH 3-48	13-89	0055747
TAP, THREADING-INCH 3/8-16	13-89	0450336
TAP, THREADING-INCH 3/8-24	13-89	0450422
TAP, THREADING-INCH 4-36	13-89	0004006
TAP, THREADING-INCH 4-40	13-89	0055748
TAP, THREADING-INCH 5-40	13-89	0004007
TAP, THREADING-INCH 5/16-18	13-89	0055761
TAP, THREADING-INCH 5/16-24	13-89	0055760
TAP, THREADING-INCH 5/16-32	13-89	0450288
TAP, THREADING-INCH 6-32	13-89	0004008
TAP, THREADING-INCH 6-40	13-89	0055750
TAP, THREADING-INCH 8-32	13-89	0004009
TAP, THREADING-INCH 8-40	13-89	0055753
TAP, THREADING-METRIC M2	13-89	1749288
TAP, THREADING-METRIC M2.5	13-89	1749289
TAP, THREADING-METRIC M3	13-89	1749290
TAP, THREADING-METRIC M3.5	13-89	1749291
TAP, THREADING-METRIC M4	13-89	1749292
TAP, THREADING-METRIC M5	13-89	1749293
TAP, THREADING-METRIC M6	13-89	1749294

## ALPHABETICAL INDEX

DESCRIPTION	GP-PG	PT NO.
TAP, THREADING-METRIC M8	13-89	1749295
TAP- 1/4-20	13-93	0450172
TAP- 1/4-24	13-93	0055759
TAP- 1/4-28	13-93	0450273
TAP- 10-24	13-93	0055754
TAP- 10-30	13-93	0055755
TAP- 10/32	13-93	0004010
TAP- 12-24	13-93	0055757
TAP- 14-24	13-93	0450171
TAP- 2-56	13-93	0055746
TAP- 3-48	13-93	0055747
TAP- 3/8-16	13-93	0450336
TAP- 4-40	13-93	0055748
TAP- 5/16-18	13-93	0055761
TAP- 5/16-24	13-93	0055760
TAP- 5/16-32	13-93	0450288
TAP- 6-40	13-93	0055750
TAP- 6/32	13-93	0004008
TAP- 8/32	13-93	0004009
TAPE ELECT, 1/2" X 36 YDS	19-139	0450692
TAPE, FILAMENT PACKING	19-139	9900502
TAPE, FILAMENT, 1/2" X 36 YD	19-139	0451545
TAPE, FRICTION, 3/4" X 1/2 LB	19-139	0450695
TAPE, FRICTION, 3/4" X 45'	19-139	0450695
TAPE, GREEN, 2321	19-139	2200043
TAPE, HAZARD 2" X 54'	19-139	1762542
TAPE, MASKING, PAPER, 1"	19-139	0451546
TAPE, PRINTABLE, 3/8"	19-139	0241663
TEMPLATE, MC ALIGNMENT	7-69	0900510
TENON REMOVAL TOOL	6-56	9900708
TERMINATOR, BUS, IPAT ASM	17-125	2282675
TERMINATOR, TAG, IPAT ASM	17-125	5440650
TEST LAMP 48V	17-129	0802000
TEST LEAD 6,6 FT, 6-32 GREEN	15-111	4261109
TEST LEAD 6,6 FT, 6-32 RED	15-111	4261108
TEST SET, MODEM INTERFACE	17-127	0453637
TESTER ASM, CE 3270	17-127	2570250
TESTER OVERLAY 1404-2540	17-128	0838173
TESTER OVERLAY 1442 N 1	17-128	0634499
TESTER OVERLAY 1443 N 1	17-128	0820324
TESTER OVERLAY 2250 II	17-128	5724376
TESTER OVERLAY 2314-2844	17-128	2250852
TESTER OVERLAY 2501	17-128	0647228



## GROUP 20

## ALPHABETICAL INDEX

DESCRIPTION	GP-PG	PT NO.
TESTER OVERLAY 2501B	17-128	0647521
TESTER OVERLAY 2520B	17-128	0647625
TESTER OVERLAY 2540-1403	17-128	0837890
TESTER OVERLAY 2671-2822	17-128	8029740
TESTER OVERLAY 2701-SDA II	17-128	5159315
TESTER OVERLAY 2701-TA II	17-128	5740508
TESTER OVERLAY 2821-1403	17-128	0827047
TESTER OVERLAY 2826	17-128	2984249
TESTER OVERLAY 2841	17-128	2193977
TESTER OVERLAY 360 I/O 1442	17-128	0634429
TESTER OVERLAY 360 I/O,2701	17-128	5740551
TESTER OVERLAY UCS DATA SW.	17-128	0838163
TESTER, I-O	17-128	0452400
THERMOMETER	8-75	4611153
THERMOMETER, 0 F - 220 F	8-74	0857459
THERMOMETER, 30 F - 40 F	8-75	1749001
THERMOMETER, MEMORY	8-74	0762637
THERMOMETER, RE HUMIDIGRAPHS	8-74	0453539
THERMOMETER- 0 F - 120 F	8-74	5392366
THERMOMETER- 100 F - 180 F	8-74	5258786
THREAD SEALANT	19-139	0596763
TILT DETENT ADJ, 1/8"	2-29	9900369
TILT DETENT WRENCH	1-5	9900619
TIP BENDER, TKO	7-68	9900092
TIP REPLACTABLE HOOK	15-115	0461086
TIP, BANANA 6-32	15-116	0451659
TIP, GROUND SLT SCOPE PROBE	15-115	0453167
TIP, PROBE, 6-32	15-114	0461119
	15-116	0461119
TIP, PROBE, HOOK SHANK, 6-32	15-114	0461090
	15-115	0461090
TIP, PROBE, SHANK, 6-32	15-115	0461091
TIP, RETRACTABLE HOOK	15-114	0453181
	15-115	0453181
TIP, SPEED INDICATOR, CONE	8-71	0450574
TIP, SPRING	15-115	5500864
TOOL BAG ASM, WT CE	1-3	4057140
TOOL CASE	1-2	4261102
TOOL CASE MOLDED	1-16	9900579
	1-22	9900579

## ALPHABETICAL INDEX

GROUP 20

DESCRIPTION	GP-PG	PT NO.
TOOL CASE,SLIMLINE	1-16	9900728
	1-22	9900728
TOOL SET,LARGE	1-12	1643918
	1-6	8550229
TOOL SET,MOLDED	1-12	9900579
TOOL SET,PROGRAM SUPPORT	1-12	0453663
	1-6	0453663
TOOL SET,SEL I/O	1-18	9900459
TOOL SET,SLIM LINE	1-12	9900728
TOOL SET,SMALL-BLUE	1-12	1643916
TOOL SET,SMALL-BLUE CASE	1-6	8550227
TOOL SET,SMALL-BROWN	1-12	1643917
TOOL SET,SMALL-BROWN CASE	1-6	8550228
TOOL SET,ZIPPER CASE	1-12	0451550
	1-6	0451550
TRANSFORMER LINE SCOPING	17-126	0453646
TRANSFORMER,DYNAMIC TIMER	17-126	5442707
TRIPLETT VOM LEADS W/CLIPS	16-120	9900168
TUBE AND CAP,PLASTIC,3/4"	18-131	0450638
TUBE AND CAP,PLASTIC,7/8"	18-131	0450637
TUBE,INSULATING FOR 453161	15-114	0453178
TWEEZERS	4-49	9900365
TWEEZERS JEWELER,INSULATED	4-49	0489193
TWEEZERS,BENT TIP	4-49	0489242
TWEEZERS,JEWELER	4-49	0605904
TWEEZERS,POINTED,INSULATED	4-49	4261107
TWEEZERS,SELF CLOSING	4-49	2108014
TYPE CLEANER	10-85	0451529
TYPE CLEANER,SCOTCH	10-85	0451529
UNWRAP TOOL TIP,LH	14-97	0452385
UNWRAP TOOL TIP,RH	14-97	0452384
UNWRAP TOOL,WIRE RH AND LH	14-97	0451573
VACUUM CLEANER	10-81	1646825
	10-84	9900735
VACUUM PUMP	14-101	0453091
VACUUM/PRESSURE GAUGE KIT	8-73	5495384
VALVE,POWER CLEANER	10-83	9900537
VELOCITY ADJUSTING WRENCH	2-25	9900226

## GROUP 20

## ALPHABETICAL INDEX

DESCRIPTION	GP-PG	PT NO.
VELOCITY CONT ADJ, COMPOSER	7-67	9900508
VIAL, PLASTIC WITH 2 CAPS	18-131	9900047
VIEW CASE	9-79	1851976
VIEWER, HANDHELD MICROFILM	9-79	1857009
VIEWER, STREAM, OS6, MICROSCOPE	7-67	9900601
WISE, BENCH, CLAMP BASE 3"	6-61	0450626
WISE, BENCH, CLAMP BASE, 1.40"	6-59	0489019
WISE, MECHANICS 4"	6-61	0450182
WISE, VACUUM HOLDING	6-61	0451912
WASHER, POWER CLEANER	10-83	9900567
WAX EMULSION	19-139	0450701
WHEEL, ABS, SHANK- 1 X 1-1/2"	5-52	0450551
WHEEL, ABS, SHANK- 1 X 1/2"	5-52	0450553
WHEEL, ABS, SHANK- 1/2 X 1/2"	5-52	0450552
WIRE ASSEMBLY, POWER CLEANER	10-83	9900573
WIRE CADDY 10.0", 50 OHM	14-107	0453928
WIRE CADDY 10.0", 90 OHM	14-106	2360010
WIRE CADDY 11.0", 50 OHM	14-108	0453929
WIRE CADDY 11.0", 90 OHM	14-106	2360011
WIRE CADDY 12.0", 50 OHM	14-108	0453930
WIRE CADDY 12.0", 90 OHM	14-106	2360012
WIRE CADDY 13.0", 50 OHM	14-108	0453931
WIRE CADDY 13.0", 90 OHM	14-106	2360013
WIRE CADDY 14.0", 50 OHM	14-108	0453932
WIRE CADDY 14.0", 90 OHM	14-107	2360014
WIRE CADDY 15.0", 50 OHM	14-108	0453933
WIRE CADDY 15.0", 90 OHM	14-107	2360015
WIRE CADDY 16.0", 50 OHM	14-108	0453934
WIRE CADDY 16.0", 90 OHM	14-107	2360016
WIRE CADDY 17.0", 50 OHM	14-108	0453935
WIRE CADDY 17.0", 90 OHM	14-107	2360017
		2360017
WIRE CADDY 18.0", 50 OHM	14-108	0453936
WIRE CADDY 18.0", 90 OHM	14-107	2360018
WIRE CADDY 19.0", 50 OHM	14-108	0453937
WIRE CADDY 19.0", 90 OHM	14-107	2360019
WIRE CADDY 2.5", 50 OHM	14-108	2360089
WIRE CADDY 2.5", 90 OHM	14-106	2360078
WIRE CADDY 20.0", 50 OHM	14-108	0453938
WIRE CADDY 20.0", 90 OHM	14-107	2360020
WIRE CADDY 3.0", 50 OHM	14-107	0053918
WIRE CADDY 3.0", 90 OHM	14-106	2360000

## ALPHABETICAL INDEX

GROUP 20

DESCRIPTION	GP-PG	PT NO.
WIRE CADDY 3.5",50 OHM	14-107	0453919
WIRE CADDY 3.5",90 OHM	14-106	2360001
WIRE CADDY 4.0",50 OHM	14-107	0453920
WIRE CADDY 4.0",90 OHM	14-106	2360002
WIRE CADDY 4.5",50 OHM	14-107	0453921
WIRE CADDY 4.5",90 OHM	14-106	2360003
WIRE CADDY 5.0",50 OHM	14-107	0453922
WIRE CADDY 5.0",90 OHM	14-106	2360004
WIRE CADDY 5.5",50 OHM	14-107	0453923
WIRE CADDY 5.5",90 OHM	14-106	2360005
WIRE CADDY 6.0",50 OHM	14-107	0453924
WIRE CADDY 6.0",90 OHM	14-106	2360006
WIRE CADDY 7.0",50 OHM	14-107	0453925
WIRE CADDY 7.0",90 OHM	14-106	2360007
WIRE CADDY 8.0",50 OHM	14-107	0453926
WIRE CADDY 8.0",90 OHM	14-106	2360008
WIRE CADDY 9.0",50 OHM	14-107	0453927
WIRE CADDY 9.0",90 OHM	14-106	2360009
WIRE CADDY HOUSING	14-106	0453917
	14-107	0453917
WIRE CADDY MID-AIR SPLICE	14-108	2360370
WIRE CADDY TRMNR,90 OHM	14-106	0453738
WIRE CADDY,50 OHM	14-107	0453900
WIRE CADDY,90 OHM	14-106	0453903
WIRE CADDY,PRE-CUT,30 AWG	14-103	0453106
WIRE COMPLEMENT,10.0"	14-103	0815105
WIRE COMPLEMENT,11.0"	14-103	0815106
WIRE COMPLEMENT,12.0"	14-103	0815107
WIRE COMPLEMENT,13.0"	14-103	0815108
WIRE COMPLEMENT,14.0"	14-103	0815109
WIRE COMPLEMENT,15.0"	14-103	0815110
WIRE COMPLEMENT,16.0"	14-103	0815111
WIRE COMPLEMENT,17.0"	14-103	0815112
WIRE COMPLEMENT,17.0",BL-WH	14-103	0815113
WIRE COMPLEMENT,4.0"	14-103	0815094
WIRE COMPLEMENT,4.5"	14-103	0815095
WIRE COMPLEMENT,5.0"	14-103	0815096
WIRE COMPLEMENT,5.5"	14-103	0815097
WIRE COMPLEMENT,6.0"	14-103	0815098
WIRE COMPLEMENT,6.5"	14-103	0815099
WIRE COMPLEMENT,7.0"	14-103	0815100
WIRE COMPLEMENT,7.5"	14-103	0815101

## GROUP 20

## ALPHABETICAL INDEX

DESCRIPTION	GP-PG	PT NO.
WIRE COMPLEMENT, 8.0"	14-103	0815102
WIRE COMPLEMENT, 8.5"	14-103	0815103
WIRE COMPLEMENT, 9.0"	14-103	0815104
WIRE REEL 275', SLT	14-100	0815906
WIRE REEL 275', SLT MST-1-2	14-100	0815807
WIRE REEL ASM 275', MST-1-2	14-100	0815905
WIRE ROLL 100', YELLOW	14-100	1264286
WIRE STRIPPER	4-47	0461075
WIRE STRIPPER, 16-26 AWG	4-46	0450694
WIRE WRAP BIT, 20 AWG	14-97	0461011
WIRE WRAP BIT, 22 AWG	14-97	0461010
WIRE WRAP BIT, 24 AWG	14-97	0461235
WIRE WRAP BIT, 26 AWG	14-97	0461063
WIRE WRAP BIT, SLT, MST-1-2	14-97	9263122
WIRE WRAP EXTENSION MST-2	14-98	2360355
WIRE WRAP SLEEVE, 20 AWG	14-98	0461016
WIRE WRAP SLEEVE, 22-24 AWG	14-98	0461015
WIRE WRAP SLEEVE, 26 AWG	14-98	0461014
WIRE WRAP SLEEVE, SLT, MST-1	14-98	9328353
WIRE WRAP TOOL, 20-22 AWG	14-97	0451140
WIRE WRAP TOOL, 24-26 AWG	14-97	0451142
WIRE WRAP TOOL, HAND	14-97	0451572
WIRE, FULCRUM TAB STOP	7-64	1012444
WIRE, FULCRUM TYPEBAR KEY	7-64	1118213
WIRE, FULCRUM TYPEBAR PIVOT	7-64	1016718
WRAP TOOL HAND NO. 30	14-98	0452527
WRENCH AND SOCKET SET ASM	2-23	1650830
WRENCH BOX, 11/16 X 3/4"	2-28	0856481
WRENCH, 1/4 IN., OFFSET	2-31	0605903
WRENCH, 30-60 DEG, 2314	2-30	2200464
WRENCH, 4 FLUTE, N.2	1-5	9900173
WRENCH, 4 FLUTE, N.4	1-5	9900204
WRENCH, 4 FLUTE, N.5	1-5	9900066
WRENCH, 4 FLUTE, N.6	1-5	9900101
WRENCH, ADJUSTABLE- 10"	2-28	0450177
WRENCH, ADJUSTABLE- 12"	2-28	2200031
WRENCH, ADJUSTABLE- 6"	2-28	1650894
WRENCH, ADJUSTABLE- 8"	2-28	0454353
WRENCH, BOX & OPEN END, 1/2"	2-25	1650849
WRENCH, BOX & OPEN END, 1/4"	2-25	1650844
		0461617
WRENCH, BOX & OPEN END, 10 MM	2-25	1749243

## ALPHABETICAL INDEX

DESCRIPTION	GP-PG	PT NO.
WRENCH, BOX & OPEN END, 11/32"	2-25	1650846
WRENCH, BOX & OPEN END, 13 MM	2-25	1749244
WRENCH, BOX & OPEN END, 3/8"	2-25	1650847
WRENCH, BOX & OPEN END, 5 MM	2-25	1857022
WRENCH, BOX & OPEN END, 5.5 MM	2-25	9900768
WRENCH, BOX & OPEN END, 5/16"	2-25	1650845
WRENCH, BOX & OPEN END, 6 MM	2-25	1749261
WRENCH, BOX & OPEN END, 7 MM	2-25	1749242
WRENCH, BOX & OPEN END, 7/16"	2-25	1650848
WRENCH, BOX & OPEN END, 8/16"	2-25	1650850
WRENCH, BOX END 1/4 X 5/16"	2-26	9900426
WRENCH, BOX END 3/8 X 7/16"	2-26	9900182
WRENCH, BOX, 3/8 X 7/16"	2-28	9900182
WRENCH, BOX, 8 MM, T-HANDLE	2-32	0489239
WRENCH, CAPSTAN MOTOR 2420	2-31	2515390
WRENCH, COMBINATION- 10 MM	2-24	1749243
WRENCH, COMBINATION- 13 MM	2-24	1749244
WRENCH, COMBINATION- 5 MM	2-24	1857022
WRENCH, COMBINATION- 5.5 MM	2-24	9900768
WRENCH, COMBINATION- 6 MM	2-24	1749261
WRENCH, COMBINATION- 7 MM	2-24	1749242
WRENCH, DRUM HEAD ADJUSTING	2-31	0454350
WRENCH, FRONT DOOR, 2314	2-32	2200104
WRENCH, HEX, 9 IN. 2321	2-31	2200204
WRENCH, HEX, TAPE HEAD	2-31	0453608
WRENCH, HEX- 3 MM	2-24	1749238
WRENCH, HEX- 5 MM	2-24	1749237
WRENCH, HEX- 6 MM	2-24	1749236
WRENCH, LEVELING PAD	2-28	0453607
WRENCH, MT/ST 7/16 X 3/8"	2-26	9900422
WRENCH, OBSTRUCTION 5/16"	2-29	9900022
WRENCH, OFFSET 10 X 11 MM	2-28	0489840
WRENCH, OFFSET 9 X 9.5 MM	2-28	0489841
WRENCH, OPEN END, 1/2 X 3/8"	2-30	0489895
WRENCH, OPEN END, 1/4 X 1/4"	2-27	0605902
		0460304
WRENCH, OPEN END, 1/4 X 5/16"	2-26	9900005
WRENCH, OPEN END, 1/4" OFFSET	2-28	0460311
WRENCH, OPEN END, 1/8 X 3/16"	2-30	0450802
WRENCH, OPEN END, 1/8 X 5/32"	2-26	9900266
	2-27	9900266
WRENCH, OPEN END, 11/32 X 3/8"	2-26	9900013

## GROUP 20

## ALPHABETICAL INDEX

DESCRIPTION	GP-PG	PT NO.
WRENCH, OPEN END, 11/32"	2-27	0460309
WRENCH, OPEN END, 3/16 X 7/32"	2-26	1650843
WRENCH, OPEN END, 3/16"	2-27	0460307
WRENCH, OPEN END, 3/8"	2-27	0460306
WRENCH, OPEN END, 5-16"	2-27	0489878
WRENCH, OPEN END, 5.5 X 6 MM	2-27	0489857
WRENCH, OPEN END, 5/16"	2-27	0460305
WRENCH, OPEN END, 5/8 X 3/4"	2-26	9900090
WRENCH, OPEN END, 7/32 X 3/16"	2-27	4261090
WRENCH, OPEN END, 7/32"	2-26	9900208
	2-27	0460308
WRENCH, OPEN END, 9/16 X 5/8"	2-30	9007472
WRENCH, OPEN END, 9/32 X 11/16	2-26	2244061
WRENCH, RATCHET 1/4" DRIVE	2-29	1650887
WRENCH, RATCHET 1/4" SQ DR	2-25	1650887
WRENCH, SELECTOR, 1419	2-31	0834327
WRENCH, SOCKET, KEY PUNCH	2-31	0021213
WRENCH, SPANNER	2-32	0461129
WRENCH, SPANNER, 4"	2-32	0450128
WRENCH, TAP AND REAMER ADJ	13-90	0004046
WRENCH, TAP AND REAMER EXT	13-95	0450529
WRENCH, TAPE HEAD ADJ.	2-31	0453609
WRENCH, TILT DETENT-SEL	2-26	9900619
WRENCH, TORQUE 6 FLUTE, 4-40	8-75	2597971
WRENCH, TORQUE ADAPTER	8-75	2538009
WRENCH, TORQUE, 0-150 IN. LB	8-73	2515283
WRENCH, TORQUE, 0-600 IN. LB	8-73	2108039
WRENCH, TORQUE, 10 IN. LB	8-75	2597968
WRENCH, TORQUE, 4 IN. LB	8-75	2597969
WRENCH, TORQUE, 8 IN. LB	8-75	2598187
WRENCH, TUBE, 1/4 X 5/16"	2-28	0489902
WRENCH, TUBE, 5/16 X 3/8"	2-28	0173993
WRIST STRAP, ESD SMALL	14-99	6428167
WRIST STRAP, ESD, LARGE	1-11	6428169
	1-17	6428169
	1-4	6428169
WRIST STRAP, ESD LARGE	14-99	6428169
WRIST STRAP, ESD, SMALL	1-11	6428167
	1-17	6428167
	1-4	6428167
XENON FLASH BULB, STROBE ASM	17-128	4261075
ZIPPER TOOL CASE	1-2	4261104
	1-3	4261104

NUMERICAL INDEX

GROUP 21

PT NO.	GP-PG	PT NO.	GP-PG
0003339	10-81	0008956	13-95
0003701	10-81	0008957	13-95
0003986	13-92	0008958	13-95
0003987	13-92	0010407	7-67
0003988	13-92	0010480	7-65
0003989	13-92	0018463	5-53
0003990	13-92	0018974	5-53
0003991	13-91	0021213	2-31
0003992	13-91	0053918	14-107
0003993	13-92	0055746	13-89
0003994	13-91		13-93
0003995	13-91		
0003996	13-91	0055747	13-89
0003997	13-91		13-93
0003998	13-91		
0003999	13-91	0055748	13-89
0004000	13-91		13-93
0004001	13-91		
0004002	13-92	0055750	13-89
0004003	13-92		13-93
0004006	13-89		
0004007	13-89	0055753	13-89
0004008	13-89	0055754	13-89
	13-93		13-93
0004009	13-89	0055755	13-89
	13-93		13-93
0004010	13-89	0055757	13-89
	13-93		13-93
0004011	5-53	0055759	13-89
0004013	5-52		13-93
0004014	5-52		
0004031	6-58	0055760	13-89
0004032	6-60		13-93
0004035	6-60		
0004046	13-90	0055761	13-89
0004047	6-58		13-93
0004055	12-87	0055762	13-92
0007231	2-33	0055763	13-92
	2-35	0055764	13-92
0008955	13-95		



## GROUP 21

## NUMERICAL INDEX

<u>PT NO.</u>	<u>GP-PG</u>	<u>PT NO.</u>	<u>GP-PG</u>
0055766	13-91	0158955	5-53
0055767	13-91	0165866	1-5
0055769	13-91		5-51
0055770	13-91		
0055771	13-91	0167717	13-94
0055773	13-92	0167718	13-96
0055781	13-91	0171308	13-93
0055797	13-95		13-94
0055798	13-95		
0055799	13-95	0171320	6-55
0055800	13-95	0173257	13-96
0074530	14-105	0173258	13-96
		0173259	13-96
0074925	2-33	0173260	13-94
	2-35	0173261	13-94
		0173262	13-94
0077009	2-33	0173993	2-28
	2-35	0178397	2-33
			2-34
0104774	19-135		2-35
0105668	7-63		2-37
0112646	2-36		
0116574	2-33	0178666	13-94
	2-34	0178667	13-93
	2-35		13-96
	2-37		
0117397	19-137	0216348	19-138
0123789	2-36	0220026	6-60
0152831	8-71	0223980	19-137
0152857	2-36	0241663	19-139
0153778	11-86	0260781	19-137
0154292	13-94	0261096	19-135
0154365	13-94	0265390	19-136
0157198	6-60	0289273	19-138
0157199	6-60	0289274	19-138
0157200	6-60	0289275	19-138
0157918	13-96	0316455	17-129
0158220	13-93	0332009	15-114
	13-96	0337539	19-136
		0343641	4-47
0158333	7-64	0352407	19-138
0158799	13-94	0352465	10-85
		0352466	10-85

NUMERICAL INDEX

GROUP 21

PT NO.	GP-PG	PT NO.	GP-PG
0352561	10-85	0450163	13-91
0352605	10-85	0450164	13-91
0352606	10-85	0450165	13-91
0353887	19-139	0450166	13-91
0357830	19-138	0450167	13-91
0375277	14-103	0450168	13-91
0435610	17-126	0450169	13-92
0450001	13-96	0450170	13-92
0450002	13-94	0450171	13-88
0450008	13-96		13-93
0450011	13-93		
	13-96	0450172	13-89
			13-93
0450014	11-86		
0450017	13-95	0450177	2-28
0450030	6-55	0450179	13-92
0450037	13-92	0450182	6-61
0450038	2-35	0450224	7-67
0450047	13-94	0450236	13-94
0450048	13-94	0450237	13-94
0450050	2-36	0450238	19-137
0450052	19-137	0450253	13-94
0450054	6-56	0450256	13-92
0450055	13-95	0450257	13-92
0450057	13-96	0450258	13-92
0450058	13-94	0450259	13-92
0450108	6-56	0450262	13-92
0450109	19-136		14-102
0450126	9-78		
0450128	2-32	0450263	13-92
0450130	13-91	0450264	13-92
0450133	19-137	0450265	13-91
0450134	13-95	0450269	13-95
0450147	9-77	0450270	13-95
0450152	13-94	0450272	13-91
0450155	5-53	0450273	13-89
0450156	5-53		13-93
0450157	5-53		
0450158	8-71	0450277	13-91
0450159	13-92	0450278	13-91
0450160	13-92	0450279	13-92
0450161	13-92	0450287	13-91
0450162	13-92	0450288	13-89

## GROUP 21

## NUMERICAL INDEX

<u>PT NO.</u>	<u>GP-PG</u>	<u>PT NO.</u>	<u>GP-PG</u>
0450288	13-93	0450467	18-131 2-30
0450289	13-91	0450503	5-53
0450290	13-91	0450514	6-58
0450291	13-92	0450529	13-95
0450298	13-91	0450540	6-55
0450299	13-92	0450541	7-65
0450300	13-91	0450544	7-63
0450301	13-91	0450546	6-58
0450302	13-92	0450550	7-64
0450303	13-92	0450551	5-52
0450315	19-137	0450552	5-52
0450336	13-89 13-93	0450553	5-52
0450364	7-67	0450554	6-56
0450365	6-57	0450556	19-137
0450369	13-95	0450566	11-86
0450371	13-95	0450567	5-51
0450372	2-33	0450571	3-41
0450373	2-33 2-34 2-35 2-37	0450574	8-71
0450391	6-60	0450608	19-138
0450405	19-138	0450626	6-61
0450407	6-60	0450633	19-138
0450421	13-95	0450637	18-131
0450422	13-89	0450638	18-131
0450426	5-52	0450668	19-137
0450432	5-53	0450669	19-137
0450433	5-53	0450670	19-137
0450443	11-86	0450676	19-137
0450448	6-60	0450692	19-139
0450450	19-135	0450694	14-98 4-46
0450453	2-35	0450695	19-139
0450454	2-35	0450701	19-139
0450455	2-35	0450713	11-86
0450456	6-60	0450716	13-91
0450457	6-60	0450721	2-30
0450459	8-71	0450722	2-30
0450465	18-133	0450732	10-81
		0450745	7-63

NUMERICAL INDEX

GROUP 21

PT NO.	GP-PG	PT NO.	GP-PG
0450786	4-45		1-16
0450802	2-30		1-6
0450813	11-86		
0450815	2-34	0451553	2-33
	2-37		2-34
			2-35
0450837	15-109		2-37
	15-110		
		0451555	10-81
0450891	19-139	0451572	14-97
0450898	4-48	0451573	14-97
0450919	8-75	0451659	15-116
0450935	6-60	0451893	7-66
0450936	19-136	0451912	6-61
	19-138	0451913	2-25
		0451914	8-71
0450948	8-72	0451915	8-71
0450949	8-72	0451916	8-71
0450976	8-73	0451921	8-73
0451030	6-61	0452220	2-35
0451049	8-71	0452368	4-45
0451053	19-138	0452384	14-97
0451075	14-98	0452385	14-97
0451110	19-137	0452395	2-33
0451126	8-72		2-36
0451130	3-41		
0451131	3-41	0452397	6-60
0451132	3-41	0452399	14-98
0451133	3-41	0452400	17-128
0451134	3-41	0452457	7-66
0451135	3-41	0452527	14-98
0451140	14-97	0452528	14-101
0451142	14-97	0452561	14-101
0451148	14-102	0452568	14-98
	2-23	0452572	14-105
0451290	8-73	0452616	14-102
0451529	10-85	0452617	14-102
		0452618	14-102
0451545	19-139	0452626	14-101
0451546	19-139	0452642	9-79
0451550	1-10	0452803	16-118
	1-12	0452815	6-57

## GROUP 21

## NUMERICAL INDEX

PT NO.	GP-PG	PT NO.	GP-PG
0453037	14-102	0453185	15-114
0453047	15-114	0453189	15-114
0453059	14-105	0453194	15-114
0453061	14-105	0453198	4-47
0453063	14-101	0453199	15-110
0453064	14-101	0453201	15-114
0453066	14-101	0453203	16-119
0453067	14-101	0453212	16-118
0453084	14-101	0453214	15-112
0453085	14-101	0453215	15-112
0453091	14-101	0453222	1-11
0453106	14-103		1-17
0453112	14-102		1-4
0453119	14-105		16-123
0453120	14-105	0453225	14-104
0453134	14-101	0453390	14-102
0453135	14-102	0453391	19-138
0453144	6-57	0453397	2-29
0453147	15-117	0453400	14-99
0453148	15-117		4-49
0453149	15-117	0453404	9-79
0453154	15-117	0453428	14-102
0453164	15-114	0453443	14-102
	15-115	0453444	14-102
0453167	15-114	0453446	14-104
	15-115	0453454	14-108
	16-118	0453461	14-105
	16-123	0453467	14-101
0453168	15-114	0453473	14-102
0453178	15-114	0453506	6-59
0453179	15-114	0453509	6-57
0453180	15-114	0453510	4-48
	15-115	0453514	16-124
		0453518	9-77
0453181	15-114	0453520	15-114
	15-115	0453521	1-5
			6-56
0453183	15-114	0453522	19-135
0453184	15-110	0453523	7-65
	15-114	0453524	7-65

NUMERICAL INDEX

GROUP 21

PT NO.	GP-PG	PT NO.	GP-PG
0453525	7-65	0453644	15-117
0453526	7-65	0453646	17-126
0453527	7-65	0453663	1-10
0453528	7-65		1-12
0453530	7-65		1-16
0453531	7-65		1-6
0453536	1-5		
	10-81	0453682	19-138
	10-85	0453693	9-77
		0453697	16-124
0453539	8-74	0453705	15-110
0453548	15-109	0453718	15-110
0453549	15-117	0453738	14-106
0453550	15-112	0453740	14-108
0453554	16-122	0453766	14-101
0453555	16-122	0453773	14-102
0453559	19-135	0453774	14-102
	9-77	0453777	14-102
		0453778	14-102
0453561	18-133	0453780	14-105
0453562	18-133	0453808	14-105
0453568	8-73		
0453570	8-73	0453824	14-99
0453572	19-135	0453826	14-104
0453575	4-48		16-118
0453587	14-105		16-123
0453588	14-101		
0453594	18-131	0453834	14-104
0453600	17-126	0453836	14-104
0453604	7-65	0453857	14-102
0453605	16-118	0453888	14-102
0453606	16-122	0453900	14-107
0453607	2-28	0453903	14-106
0453608	2-31	0453915	15-110
0453609	2-31	0453917	14-106
0453618	14-103		14-107
0453637	17-127		
0453638	19-135	0453919	14-107
0453639	19-135	0453920	14-107
0453640	19-135	0453921	14-107
0453641	19-135	0453922	14-107
0453642	19-135	0453923	14-107
0453643	19-135	0453924	14-107

## GROUP 21

## NUMERICAL INDEX

PT NO.	GP-PG	PT NO.	GP-PG
0453925	14-107	0460315	6-60
0453926	14-107	0460622	4-46
0453927	14-107	0460807	4-47
0453928	14-107	0460808	4-45
0453929	14-108	0460811	3-43
0453930	14-108	0460812	2-30
0453931	14-108	0460820	6-61
0453932	14-108	0460870	8-71
0453933	14-108	0460947	2-32
0453934	14-108	0461010	14-97
0453935	14-108	0461011	14-97
0453936	14-108	0461014	14-98
0453937	14-108	0461015	14-98
0453938	14-108	0461016	14-98
0453942	14-105	0461043	6-59
0453944	14-105	0461044	6-59
		0461046	6-59
0453954	15-110	0461060	6-59
0454065	6-60	0461061	6-59
0454302	13-90	0461063	14-97
0454326	7-66	0461070	4-48
0454332	12-87	0461072	6-59
0454350	2-31	0461073	6-59
0454352	18-132	0461074	6-61
0454353	2-28	0461075	4-47
0460028	7-66	0461076	4-47
0460108	9-77	0461086	15-115
0460139	6-58	0461090	15-114
0460169	6-58		15-115
0460194	12-88		
0460258	3-41	0461091	15-115
0460294	4-48		16-118
0460303	6-60		
0460304	2-27	0461117	8-72
0460305	2-27	0461119	15-114
0460306	2-27		15-116
0460307	2-27		
0460308	2-27	0461129	2-32
0460309	2-27	0461137	2-32
0460311	2-28	0461141	8-71
0460312	2-35	0461158	4-48
0460313	2-35	0461159	15-114
0460314	2-35		15-116

NUMERICAL INDEX

GROUP 21

PT NO.	GP-PG	PT NO.	GP-PG
0461159	16-118 16-123	0489883	1-11 1-4 12-87
0461228	3-42	0489895	2-30
0461235	14-97	0489898	8-72
0461262	14-98	0489902	2-28
0461275	2-32	0489905	4-47
0461305	19-138	0489942	6-57
0461420	6-59	0489949	6-57
0461450	8-73	0489967	4-46
0461545	14-105	0489968	4-46
0461556	14-105	0489969	4-46
0461617	2-25	0489982	3-41
0461621	19-136	0512893	9-77
0471519	19-138	0556945	10-85
0477567	19-137	0596763	19-139
0483151	19-136	0603717	19-137
0489017	4-47	0603910	19-135
0489019	6-59	0605902	2-27
0489036	1-5 3-41	0605903	2-31
		0605904	4-49
0489076	5-52	0605908	6-60
0489136	3-42	0605960	19-135
0489146	3-42	0608183	7-66
0489150	7-67	0610147	7-66
0489174	2-30	0615960	19-135
0489185	8-71	0616185	13-95
0489193	4-49	0627953	6-59
0489239	2-32	0634429	17-128
0489242	4-49	0634499	17-128
0489806	15-116	0634779	19-137
0489840	2-28	0641458	19-138
0489841	2-28	0641462	19-139
0489857	2-27	0647228	17-128
0489878	2-27	0647521	17-128
0489881	1-11 1-4 12-87	0647625	17-128
		0650013	6-60
		0667329	8-73
		0749257	8-74
0489882	1-11 1-4 12-87	0762637	8-74
		0771494	19-138
		0771625	19-137



## GROUP 21

## NUMERICAL INDEX

<u>PT NO.</u>	<u>GP-PG</u>	<u>PT NO.</u>	<u>GP-PG</u>
0771627	19-137	0865015	14-108
0771674	19-137	0889524	19-138
0771754	19-138	0892118	14-105
0771821	19-137	0900427	7-66
0771847	19-138	0900510	7-69
0802000	17-129	0900627	7-68
0806533	8-72	0961343	10-81
0815094	14-103	1012444	7-64
0815095	14-103	1016718	7-64
0815096	14-103	1118213	7-64
0815097	14-103	1143198	14-103
0815098	14-103	1236595	19-137
0815099	14-103	1244747	10-84
0815100	14-103	1264286	14-100
0815101	14-103	1268575	19-135
0815102	14-103	1280017	19-138
0815103	14-103	1280018	19-138
0815104	14-103	1280055	19-135
0815105	14-103	1280057	18-132
0815106	14-103	1280441	19-137
0815107	14-103	1280442	19-137
0815108	14-103	1280443	19-138
0815109	14-103	1280444	19-138
0815110	14-103	1294241	10-84
0815111	14-103	1310707	14-100
0815112	14-103	1310714	15-110
0815113	14-103	1354922	19-135
0815905	14-100	1453794	17-125
0815906	14-100	1463469	17-125
0815907	14-100	1467853	17-129
0817971	16-122	1467855	17-129
0820324	17-128	1475938	17-125
0827047	17-128	1477752	10-84
0829117	14-105	1477753	10-84
0829119	14-105	1477925	7-64
0834327	2-31	1483784	17-125
0837890	17-128	1492130	17-125
0838163	17-128	1496500	17-125
0838173	17-128	1496625	17-125
0848204	8-73	1608809	19-137
0848205	8-73	1641140	17-125
0856481	2-28	1641153	17-125
0857459	8-74	1641154	17-125

NUMERICAL INDEX

GROUP 21

PT NO.	GP-PG	PT NO.	GP-PG
1641158	17-125	1650832	2-24
1641279	17-126	1650833	2-24
1643916	1-12	1650834	2-24
	1-15	1650835	2-24
1643917	1-12	1650836	2-24
	1-15	1650837	2-24
1643918	1-12	1650838	2-24
	1-13	1650839	2-24
1644320	17-129	1650840	2-29
1644326	17-126	1650841	2-29
1646825	10-81	1650842	2-29
1646826	10-81	1650843	2-26
1646827	10-81	1650844	2-25
1647116	16-124	1650845	2-25
1650755	17-129	1650846	2-25
1650758	3-41	1650847	2-25
1650761	15-109	1650848	2-25
1650762	15-109	1650849	2-25
1650763	15-109	1650850	2-25
1650764	15-109	1650852	3-40
1650765	15-109	1650853	3-40
1650766	15-109	1650854	3-40
1650767	15-109	1650856	3-40
1650774	19-135	1650858	3-40
1650776	15-109	1650859	3-40
1650778	15-109	1650860	3-40
1650782	15-112	1650861	3-40
1650786	12-88	1650862	3-40
1650787	12-88	1650863	3-40
1650788	12-88	1650864	4-45
1650792	16-123	1650865	4-45
1650800	10-85	1650866	4-45
	19-135	1650871	3-40
	19-138	1650874	3-41
1650830	2-23	1650875	3-41
1650831	2-24	1650882	15-109
		1650887	2-23
			2-25
			2-29
			5-53
1650894	2-28		
1650948	19-132		

## GROUP 21

## NUMERICAL INDEX

PT NO.	GP-PG	PT NO.	GP-PG
1650976	19-138		16-124
1650977	19-138		
1748252	19-135	1749249	16-121
1749000	15-117	1749250	16-121
1749001	8-75	1749251	15-116
1749231	16-124		16-124
1749232	16-124		
1749233	16-124	1749252	16-122
1749235	2-24		16-124
1749236	2-24		
	2-35	1749253	16-122
			16-124
1749237	2-24		
	2-35	1749255	15-116
			16-124
1749238	2-24		
	2-35	1749256	8-74
		1749258	8-74
1749239	2-24	1749259	8-74
		1749260	8-74
1749240	2-24	1749261	2-24
			2-25
1749241	2-24		
		1749262	2-24
1749242	2-24		
	2-25	1749264	13-90
		1749267	11-86
1749243	2-24	1749281	19-135
	2-25	1749288	13-89
		1749289	13-89
1749244	2-24	1749290	13-89
	2-25	1749291	13-89
		1749292	13-89
1749245	2-24	1749293	13-89
	7-63	1749294	13-89
		1749295	13-89
1749246	2-24	1749299	16-124
	8-71	1753726	15-117
		1762542	19-139
1749247	15-116	1762848	17-127
	16-124	1762853	17-127
		1762920	16-122
1749248	15-116	1762921	16-122

NUMERICAL INDEX

GROUP 21

PT NO.	GP-PG	PT NO.	GP-PG
1762922	16-118		2-34
1797703	19-138		2-35
1805216	2-29		2-37
1811804	17-126		
1851976	9-79	2108493	6-57
1851977	9-79	2108498	2-36
1851978	9-79	2108612	8-72
1851995	19-136	2108626	2-36
1852046	18-133	2108721	19-136
1857007	18-133	2108723	19-137
1857009	9-79	2108746	8-73
1857018	17-125	2108766	3-42
1857019	3-40	2108860	6-59
1857020	3-40	2108914	2-29
1857021	2-24	2108930	10-84
			10-85
1857022	2-24		
	2-25	2111942	8-73
1863715	7-63	2115252	19-136
1864853	16-120	2115444	19-138
	3-41	2123106	10-85
		2127714	19-137
1864854	4-46	2127892	6-57
1864856	11-86	2133355	19-138
1864873	17-127	2155966	19-139
1865015	17-126	2162567	10-85
1978459	6-60	2164584	19-136
2102025	12-87	2175928	19-135
2106774	19-138	2193977	17-128
2108014	4-49	2197195	3-42
2108039	8-73	2200031	2-28
2108040	2-29	2200032	19-136
2108180	19-137	2200040	8-74
2108181	19-136	2200041	19-136
2108184	19-137	2200043	19-139
2108312	8-73	2200051	2-36
2108315	2-33	2200101	4-47
	2-35	2200103	6-61
		2200104	2-32
		2200118	19-137
2108398	6-59	2200161	2-29
2108467	2-35	2200176	2-32
2108490	2-33	2200200	19-139

## GROUP 21

## NUMERICAL INDEX

PT NO.	GP-PG	PT NO.	GP-PG
2200204	2-31	2512088	8-73
2200205	6-61	2512794	8-73
2200464	2-30	2513590	10-85
2200698	7-68	2515283	8-73
2244061	2-26	2515390	2-31
2250852	17-128	2536581	7-63
2282675	17-125	2536582	7-63
2286522	19-139	2536583	7-63
2286679	8-75	2538009	8-75
2360000	14-106	2538084	8-73
2360001	14-106	2538137	8-73
2360002	14-106	2570250	17-127
2360003	14-106	2588263	16-118
2360004	14-106		16-123
2360005	14-106		
2360006	14-106	2597968	8-75
2360007	14-106	2597969	8-75
2360008	14-106	2597970	8-75
2360009	14-106	2597971	8-75
2360010	14-106	2598041	7-63
2360011	14-106	2598042	7-63
2360012	14-106	2598179	7-63
2360013	14-106	2598187	8-75
2360014	14-107	2600559	8-73
2360015	14-107	2648326	19-135
2360016	14-107	2704117	6-56
2360017	14-107	2728116	17-127
		2728186	9-77
2360018	14-107	2728225	14-99
2360019	14-107	2728228	14-99
2360020	14-107	2728231	14-99
2360078	14-106	2728246	14-99
2360089	14-108	2728259	16-118
2360355	14-98	2744699	19-137
2360370	14-107	2984249	17-128
	14-108	4057140	1-3
2360383	14-104	4057143	3-40
2360390	14-105	4057150	3-40
2360393	14-105	4098027	10-84
2360406	14-105	4116511	9-77
2494907	6-58	4116650	9-77
2507587	10-85	4136358	19-135

NUMERICAL INDEX

GROUP 21

PT NO.	GP-PG	PT NO.	GP-PG
4136379	19-135'	5159315	17-128
4136932	19-137	5230032	12-87
4136933	19-136	5230092	4-47
4136934	19-137	5246316	19-135
4261006	15-116	5258784	8-72
4261074	17-128	5258786	8-74
4261075	17-128	5353889	14-103
4261076	9-79		14-105
4261079	3-43		
4261080	15-116	5362303	17-125
4261089	18-131	5373499	9-77
4261090	2-27	5392366	8-74
4261091	17-128	5392435	19-136
4261094	17-128	5392438	19-136
4261101	11-86	5440650	17-125
4261102	1-2	5442707	17-126
4261104	1-2	5442710	17-126
	1-3	5442712	17-126
		5442715	17-126
4261107	4-49	5442867	19-135
4261108	15-111	5442868	19-137
4261109	15-111	5495151	15-111
4261124	9-77	5495384	8-73
4351049	5-52	5495385	8-73
4351130	5-52	5500746	17-126
4351136	5-51	5500748	17-126
4351137	5-51	5500749	17-126
4351138	5-51	5500750	15-112
4351140	5-51		15-114
4351141	5-51		
4351166	5-53	5500864	15-115
4357142	3-40	5500898	15-111
4463820	2-29	5500899	15-111
4611153	8-75	5500900	15-111
4690840	5-52		16-118
4691431	10-84		16-123
4760541	3-39		
4760542	3-39	5500901	15-111
4793775	19-135		16-118
4900655	16-123		
5133781	17-127	5500902	15-111
5144304	19-138	5500903	15-111
5151439	12-87	5502806	19-136

## GROUP 21

## NUMERICAL INDEX

PT NO.	GP-PG	PT NO.	GP-PG
5502807	19-137	6428169	1-11
5715008	19-135		1-17
5715009	19-135		1-4
5715010	19-136		14-99
5715011	19-136	6428235	1-11
5724376	17-128		1-17
5740508	17-128		1-4
5740551	17-128		16-123
5801067	14-103	6428274	14-99
5803975	14-103	6428275	14-99
5803976	14-103		18-134
5851882	14-103		
5853341	14-108	6428316	1-11
5997461	16-118		1-17
6248881	15-113		1-4
6339648	9-80		14-99
6339663	17-126		
	17-127	6428879	18-133
		6428880	15-113
6339684	17-127	6428882	15-113
6339709	17-126	6428897	16-121
	17-127	7030589	2-29
		7367477	19-137
6428059	15-111	7395196	18-132
6428064	15-111	7838680	15-110
6428066	15-111		15-111
6428104	1-11	7838682	16-120
	1-17	7838683	16-120
	1-4	7838684	16-120
	16-120	7838685	16-120
		7838687	16-120
6428110	16-120	7838688	16-120
6428111	16-120	7838689	16-120
6428114	15-111	7838690	16-120
6428141	18-134	7838691	16-120
6428166	14-99	7838692	16-120
6428167	1-11	8021710	3-42
	1-17	8021711	2-30
	1-4	8026752	19-138
	14-99	8029740	17-128
		8324621	19-137
		8324623	19-136

NUMERICAL INDEX

GROUP 21

PT NO.	GP-PG	PT NO.	GP-PG
8324624	19-136	9900016	12-88
8496274	19-138	9900019	2-34
8496278	1-11		2-36
	1-17		2-37
	1-4		
	1-7	9900022	2-29
	1-9	9900024	2-36
	16-122	9900026	12-87
		9900028	2-33
8496301	16-119		2-34
8523376	17-126		2-36
8549350	16-119		2-37
8549385	16-120		
8549388	16-122	9900029	2-34
8549389	16-122		2-36
8549392	10-81		2-37
8549394	3-40		
8549395	15-117	9900040	3-39
8549396	19-135	9900041	3-39
8549397	19-136	9900047	17-125
8549398	16-118		18-131
8550205	16-123		
8550208	16-123	9900049	18-131
8550227	1-6	9900050	19-139
	1-8	9900051	18-132
		9900052	18-132
8550228	1-6	9900058	2-34
	1-8		2-35
			2-37
8550229	1-6	9900059	6-55
	1-7	9900060	3-40
		9900062	2-34
8565942	16-123		2-35
9007472	2-30		2-37
9261088	18-132		
9263122	14-97		
9328353	14-98	9900064	4-45
9900004	10-81	9900066	1-5
9900005	2-26		2-34
9900007	5-51		2-36
9900008	1-19		2-37
9900013	2-26		
9900014	10-81	9900070	3-39



## GROUP 21

## NUMERICAL INDEX

<u>PT NO.</u>	<u>GP-PG</u>	<u>PT NO.</u>	<u>GP-PG</u>
9900070	3-40		2-37
9900073	18-132	9900176	17-129
9900076	3-41	9900177	19-138
9900077	13-95	9900178	18-132
9900081	9-77	9900182	2-26
9900084	6-60		2-28
9900089	5-53		
9900090	2-26	9900193	16-121
9900092	7-68	9900200	2-33
9900093	1-5		2-34
	7-68		2-36
			2-37
9900094	7-68		
9900101	1-5	9900202	2-34
	2-34		2-35
	2-36		2-37
	2-37		
9900102	2-33	9900204	1-5
	2-34		2-34
	2-36		2-37
	2-37		
9900103	2-33	9900206	6-57
	2-34	9900208	2-26
	2-36	9900210	6-55
	2-37	9900212	3-40
		9900216	2-33
			2-34
			2-36
			2-37
9900105	6-55		
9900107	13-90	9900226	2-25
9900108	11-86	9900233	4-45
9900159	17-129	9900242	2-25
9900167	1-11	9900253	7-65
	1-17	9900254	6-55
	1-22	9900255	2-33
	1-4		2-34
	16-120		2-36
			2-37
9900168	16-120	9900265	8-71
9900173	1-5	9900266	2-26
	2-34		
	2-36		

NUMERICAL INDEX

GROUP 21

PT NO.	GP-PG	PT NO.	GP-PG
9900266	2-27	9900468	7-63
9900268	4-48	9900502	19-139
9900271	11-86	9900503	17-129
9900317	4-46	9900505	7-68
9900323	18-131	9900507	18-131
9900327	18-131	9900508	7-67
9900328	3-40	9900516	17-129
9900337	3-43	9900519	7-65
9900339	2-34	9900521	4-46
	2-37	9900523	7-65
9900358	2-34	9900524	16-121
	2-35	9900525	7-67
	2-37	9900529	17-125
9900359	5-52	9900533	7-67
9900360	5-52	9900534	1-22
9900361	3-42	9900535	10-83
9900362	3-42	9900536	10-83
9900363	3-42	9900537	10-83
9900364	3-42	9900538	10-83
9900365	4-49	9900539	10-83
9900369	2-29	9900540	10-83
9900373	1-5	9900541	10-83
	6-59	9900542	10-83
9900374	11-86	9900543	10-83
9900375	2-29	9900544	10-83
9900379	1-5	9900545	10-83
	7-64	9900546	10-83
9900382	12-88	9900547	10-83
9900387	1-5	9900548	10-83
	18-132	9900549	10-83
9900418	19-138	9900550	10-83
9900422	2-26	9900551	10-83
9900426	2-26	9900552	10-83
9900459	1-18	9900553	10-83
	1-5	9900554	10-83
9900463	17-129	9900555	10-83
		9900556	10-83
		9900558	10-83
		9900559	10-83
		9900560	10-83
		9900561	10-83
		9900562	10-83

## GROUP 21

## NUMERICAL INDEX

PT NO.	GP-PG	PT NO.	GP-PG
9900563	10-83		1-4
9900564	10-83		16-123
9900565	10-83		
9900566	10-83	9900632	19-135
9900567	10-83	9900633	7-67
9900568	10-83	9900635	6-55
9900569	10-83	9900638	16-122
9900570	10-83	9900640	19-136
9900572	10-83	9900641	19-136
9900573	10-83	9900642	19-136
9900574	10-83	9900643	19-136
9900575	1-5 7-66	9900644	19-136
		9900655	16-122
		9900660	18-133
9900578	11-86	9900679	19-139
9900579	1-12 1-16 1-22	9900685	7-67
		9900686	3-43
		9900687	18-133
		9900688	4-45
9900585	9-79	9900690	19-136
9900586	16-121	9900692	19-137
9900587	16-121	9900708	6-56
9900588	16-121	9900709	1-22
9900589	7-68		6-56
9900590	19-136		
9900591	19-136	9900712	3-39
9900593	18-134	9900713	3-39
9900601	7-67	9900714	4-46
9900603	9-79	9900715	2-35
9900604	9-79	9900716	2-35
9900605	13-90	9900717	2-35
9900608	3-39	9900718	6-59
9900609	3-39	9900719	10-81
9900612	6-56	9900720	3-39
9900619	1-5 2-26	9900721	3-39
9900621	1-22	9900722	3-39
9900624	7-69	9900723	3-39
9900625	7-64	9900724	10-84
9900626	7-68	9900727	6-58
9900628	1-11 1-17	9900728	1-12
			1-16
			1-22

PT NO.	GP-PG
9900729	16-120
9900730	7-69
9900734	10-84
9900735	10-84
9900736	10-84
9900747	18-134
9900764	6-58
9900766	3-39
9900767	3-39
9900768	2-24
	2-25

**READER'S  
COMMENT  
FORM**

**General Service Tools  
Order No. S131-0075-3**

This form may be used to communicate your views about this publication. They will be sent to the author's department for whatever review and action, if any, are deemed appropriate. IBM may use or distribute any of the information you supply in any way it believes appropriate without incurring any obligation whatever. You may, of course, continue to use the information you supply.

**Note:** Copies of IBM publications are not stocked at the location to which this form is addressed. Please direct any requests for copies of publications, or for assistance in using your IBM systems, to your IBM representative or to the IBM branch office serving your locality.

Possible topics for comment are:

Usefulness      Clarity      Accuracy      Completeness  
Convenience      Organization      Legibility      Durability

If you wish a reply, give your name and mailing address.

Thank you for your cooperation. No postage stamp necessary if mailed in the U.S.A. (Elsewhere, an IBM office or representative will be happy to forward your comments.)



# BUSINESS REPLY MAIL

FIRST CLASS PERMIT NO. 40 ARMONK, N.Y.

POSTAGE WILL BE PAID BY ADDRESSEE

International Business Machines Corporation  
Dept. 825  
P.O. Box 12195  
Research Triangle Park  
North Carolina 27709

NO POSTAGE  
NECESSARY  
IF MAILED  
IN THE  
UNITED STATES

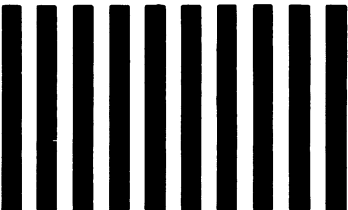

DO NOT STAPLE



S131-0075-3

**IBM**

S131-0075-3

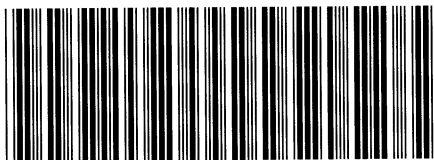

PRINTED IN U.S.A.